

Cladistics and the Origin of Birds: A Review and Two New Analyses

Authors: James, Frances C., Department of Biological Science, Florida State University, Tallahassee, Florida 32306, USA; and, and Pourtless, John A., 1327 High Road, no. K-1, Tallahassee, Florida 32304, USA

Source: Ornithological Monographs No. 66

Published By: American Ornithological Society

URL: <https://doi.org/10.1525/om.2009.66.1.1>

BioOne Complete (complete.BioOne.org) is a full-text database of 200 subscribed and open-access titles in the biological, ecological, and environmental sciences published by nonprofit societies, associations, museums, institutions, and presses.

Your use of this PDF, the BioOne Complete website, and all posted and associated content indicates your acceptance of BioOne's Terms of Use, available at www.bioone.org/terms-of-use.

Usage of BioOne Complete content is strictly limited to personal, educational, and non-commercial use. Commercial inquiries or rights and permissions requests should be directed to the individual publisher as copyright holder.

BioOne sees sustainable scholarly publishing as an inherently collaborative enterprise connecting authors, nonprofit publishers, academic institutions, research libraries, and research funders in the common goal of maximizing access to critical research.



CLADISTICS AND THE ORIGIN OF BIRDS: A REVIEW AND TWO NEW ANALYSES

FRANCES C. JAMES^{1,3} AND JOHN A. POURTLESS IV²

¹*Department of Biological Science, Florida State University, Tallahassee, Florida 32306, USA; and*
²*1327 High Road, no. K-1, Tallahassee, Florida 32304, USA*

ABSTRACT.—The hypothesis that birds are maniraptoran theropod dinosaurs (the “BMT hypothesis”) has become widely accepted by both scientists and the general public. Criticism has usually been dismissed, often with the comment that no more parsimonious alternative has been presented with cladistic methodology. Rather than taking that position, we ask here whether the hypothesis is as overwhelmingly supported as some claim. We reanalyzed a standard matrix of 46 taxa and 208 characters from a recent paper by Clark, Norell, and Makovicky, and we found statistical support for the clades Coelurosauria and Maniraptoriformes and for a clade of birds and maniraptorans. Note, however, that because the matrix contains only birds and theropods, it assumes that the origin of birds lies within the Theropoda. In addition to this problem, Clark et al.’s (2002) matrix contains problematic assumptions of homology, especially in the palate, basipterygoid, manus, carpus, and tarsus. In an attempt to avoid these two major problems and to evaluate the BMT hypothesis and four alternative hypotheses in a comparative phylogenetic framework, we followed the recommendations of Jenner, Kearney, and Rieppel by constructing and analyzing a larger but more conservative matrix. Our matrix includes taxa from throughout the Archosauria. When the ambiguous characters were excluded, parsimony analyses with bootstrapping and successive pruning retrieved a weak clade of birds and core maniraptorans (oviraptorosaurs, troodontids, and dromaeosaurs) that also contained the early archosaur *Longisquama* and was not unambiguously associated with other theropods. When the ambiguous characters were included but coded as unknown where appropriate, the results were virtually identical. Kishino-Hasegawa tests revealed no statistical difference between the hypothesis that birds were a clade nested within the Maniraptora and the hypothesis that core clades of Maniraptora were actually flying and flightless radiations within the clade bracketed by *Archaeopteryx* and modern birds (*Aves*). Additional statistical tests showed that both the “early-archosaur” and “crocodylomorph” hypotheses are at least as well supported as the BMT hypothesis. These results show that Theropoda as presently constituted may not be monophyletic and that the verificationist approach of the BMT literature may be producing misleading studies on the origin of birds. Further research should focus on whether some maniraptorans belong within *Aves*, and whether *Aves* belongs within Theropoda or is more closely related to another archosaurian taxon. At present, uncertainties about the hypothesis that birds are maniraptoran theropods are not receiving enough attention. *Received 28 July 2008, accepted 25 January 2009.*

RESUMEN.—La hipótesis de que las aves son dinosaurios maniraptores terópodos (la teoría de BMT) ha sido extensamente aceptada por científicos y el público en general. Críticas en contra de esta hipótesis han sido usualmente rechazadas basándose en el hecho de que una alternativa más parsimoniosa no ha sido presentada usando metodología cladística. Nosotros cuestionamos si la hipótesis esta realmente tan bien respaldada como ha sido indicado previamente. Se reanalizó una matriz estándar de 46 taxones y 208 caracteres basados en el artículo publicado por James Clark, Mark Norrell y Peter Makovicky, encontrando resultados estadísticos positivos que respaldan los clados de Coelurosauria y Maniraptoriformes y para los clados de aves y Maniraptora. Sin embargo, es importante notar que ya que la matriz contiene solamente aves y terópodos, esta

³E-mail: james@bio.fsu.edu

asume que el origen de las aves se sitúa dentro del grupo de los terópodos. Adicionalmente a este problema, las matrices de Clark, Norrell y Makovick también contienen problemáticas suposiciones de homología especialmente en el paladar, basiptyergoid, manus, carpus y tarsos. Haciendo un intento en evitar estos dos grandes problemas y de evaluar la teoría de BMT y cuatro hipótesis alternativas en un marco filogenético comparativo, nosotros utilizamos las recomendaciones de Jenner, Kearney, y Rieppel construyendo y analizando una matriz más grande y conservadora. Nuestra muestra incluye diferentes taxones representantes de los arcosaurios. Cuando los caracteres ambiguos fueron excluidos, el análisis de parsimonia con bootstrapping y sucesivas podas produjeron un débil clado de aves y del núcleo de los maniraptores (oviraptoridos troodontidos dromaeosáuridos) que también contiene al arcosaurio Longisquama y no fue asociado sin ambigüedad con otros terópodos. Cuando los caracteres ambiguos fueron incluidos pero codificados como desconocidos en casos apropiados, los resultados fueron virtualmente idénticos. Los resultados de los pruebas Kishino-Hasegawa revelan que no hay una diferencia estadística entre la hipótesis que sustenta que las aves eran un clado perteneciente a los dinosaurios Maniraptores, y la hipótesis que propone que los clados de los dinosaurios Maniraptores eran radiaciones de voladores y no voladores dentro del clado bordeado por Archaeopteryx y aves modernas. Otros análisis estadísticos indican que las hipótesis del "ancestro-arcosaurio" y Crocodylomorpha son tan bien apoyadas como la hipótesis de BMT. Estos resultados demuestran que los terópodos como son constituidos hoy en día pueden no ser monofiléticos, y por lo tanto el enfoque verificador de la literatura de la BMT puede que produzca resultados erróneos sobre el origen de las aves. Mas estudios deberían enfocarse en descifrar su algunos dinosaurios maniraptores pertenecen a las aves, y si las aves pertenecen a la familia de los terópodos o si están relacionadas mas cercanamente a otro taxón de arcosaurios. Hasta el momento, no se le ha prestado mucha atención a las incertidumbres que genera la hipótesis que indica que las aves son maniraptores terópodos.

INTRODUCTION

THE CURRENT CONSENSUS hypothesis about the origin of birds, often called "the theropod hypothesis," states that the sister clade of Aves is among the five groups of maniraptoran theropod dinosaurs (Oviraptorosauria, Troodontidae, Dromaeosauridae, Alvarezsauridae, and Therizinosaurioidea). The Troodontidae and the Dromaeosauridae, which together constitute the Deinonychosauria (Colbert and Russell 1969, Gauthier 1986, Norell and Makovicky 2004), are generally agreed to be the sister clade of Aves. The clade uniting Deinonychosauria and Aves is sometimes labeled Paraves (e.g., Turner et al. 2007). Aves is, therefore, deeply nested within Maniraptora and Theropoda. We will call this hypothesis the "BMT hypothesis" (from "birds are maniraptoran theropod dinosaurs"). By implication, birds are avian maniraptorans, and the Oviraptorosauria, Troodontidae, Dromaeosauridae, Alvarezsauridae, and Therizinosaurioidea are nonavian maniraptorans.

The BMT hypothesis was derived from of the work of John Ostrom (1973, 1975, 1976a, b). Ostrom described extensive osteological similarities between the skeletons of the dromaeosaurid *Deinonychus* and the earliest known bird, *Archaeopteryx*. He also drew the corollary inference that bipedalism preceded the evolution of flight in birds. He

argued that *Archaeopteryx* was primarily cursorial and incapable of powered flight and that the long forelimbs of dromaeosaurs like *Deinonychus* were "preadapted" for flight. The BMT hypothesis was more explicitly formulated on the basis of cladistic analyses by Padian (1982), Gauthier and Padian (1985), and Gauthier (1986). Gauthier (1986) concluded that his analysis of the large dinosaur group Saurischia supported a sister-group relationship between birds and either the Deinonychosauria or the Dromaeosauridae alone.

Since the publication of Gauthier's influential 1986 paper, many more data have become available. New Cretaceous birds are known from South America, North America, Spain, Mongolia, and especially China (Padian 2004, Zhou 2004, and references therein). Remarkable bird-like maniraptorans have been found in China, and others are known from Mongolia and elsewhere (Weishampel et al. 2004, and references therein). Structures identified as feathers were reported in the compsognathid *Sinosauropteryx* in 1996 (for a detailed description, see Currie and Chen 2001), and similar structures have since been reported in other theropod taxa (see Weishampel et al. 2004, and references therein). We now know that various maniraptorans had combinations of derived avian characters, including feathers, teeth without serrations, double-condyloid quadrates, uncinata

processes on the ribs, laterally facing glenoid sockets, retroverted pubes, and pygostyles (Weishampel et al. 2004, and references therein; Kurochkin 2006a, b). The BMT hypothesis has been supported by a large number of cladistic and other studies (e.g., Padian and Chiappe 1998, Chiappe and Dyke 2002, Clark et al. 2002, Paul 2002, Witmer 2002, Padian 2004, Weishampel et al. 2004, Xu 2006, and references therein). Some matrices now include 100 taxa or more and several hundred characters (e.g., Sereno 1999, Holtz et al. 2004).

Recent books (Dingus and Rowe 1998, Gauthier and Gall 2001, Chiappe and Witmer 2002, Currie et al. 2004, Weishampel et al. 2004, Norell and Ellison 2005, Chiappe 2007) summarize these data and assert that the BMT hypothesis has revolutionized our view of all Archosauria. The hypothesis has even been hailed as one of the major discoveries of 20th-century biology and a confirmation of the validity of modern systematics (Padian 2001b, 2004; Prum 2002, 2003). As new data have become available, they have been viewed as fully supportive (Padian and Chiappe 1998; Chiappe and Dyke 2002; Prum 2002, 2003; Xu et al. 2003; Xu 2006), and, except for a few caveats (Witmer 2002), further debate has been discouraged (Padian 2001b; Prum 2002, 2003). Prum, for example, has called for the integration of ornithology as a subfield of dinosaur paleontology and urged that textbooks be rewritten in accord with the BMT hypothesis (Prum 2002, 2003).

In spite of the general consensus in support of the BMT hypothesis, concern over some of its elements has persisted. Paul (2002) has argued that the reason some maniraptoran taxa possess so many derived avian apomorphies is that they are, in fact, secondarily flightless birds that are more derived than basal avian taxa like *Archaeopteryx*. Although Paul (2002) retained a theropod ancestry for birds, support for his hypothesis would clearly complicate the consensus BMT view. A few cladistic analyses have retrieved Alvarezsauridae (e.g., Perle et al. 1993, 1994; Chiappe et al. 1998) and Oviraptorosauria (Lü et al. 2002, Maryańska et al. 2002) as birds more derived than *Archaeopteryx*, and other noncladistic studies have proposed avian status for various oviraptorosaur (Elzanowski 1999, Lü et al. 2005) and dromaeosaur taxa (Czerkas et al. 2002, Burnham 2007). These studies have provided support for elements of Paul's (2002) hypothesis.

The discovery of *Microraptor*, described as a small basal dromaeosaurid (e.g., Xu et al. 2000,

2003; Hwang et al. 2002, fig. 31), has challenged the inference that bird flight originated in cursorial taxa. Additional material indicates that *Microraptor* was probably arboreal and that it was at least able to glide and was probably capable of powered flight involving all four limbs (Xu et al. 2003, 2005; Martin 2004; Feduccia et al. 2005, 2007; Burnham 2007). Indeed, *Microraptor* is strikingly similar to the tetrapteryx (four-winged) stage in avian evolution proposed by Beebe (1915, fig. 1; Xu et al. 2003). Such data suggest that the arboreal model for the origin of bird flight should be reconsidered. Among BMT proponents, Burgers and Chiappe (1999), Burgers and Padian (2001), and Padian (2001a, 2004) have retained the cursorial rationale, but Chatterjee (1997), Witmer (2002), Zhou (2004), and Chatterjee and Templin (2004) have contended that an arboreal origin of flight can be incorporated into the BMT hypothesis. This disagreement among BMT advocates has not led them to question the basic tenets of their hypothesis.

A major concern of critics of the BMT hypothesis has been with the assumptions of homology incorporated into matrices supporting it (e.g., Martin 1991; Tarsitano 1991; Feduccia 1999, 2002). Inferences of homologies between birds and theropods in characters of the carpus, manus, and tarsus have been challenged (e.g., by Burke and Feduccia 1997; Feduccia 1999, 2002; Feduccia and Nowicki 2002; Martin 2004; Feduccia et al. 2005, 2007). As argued by Czerkas et al. (2002), Feduccia (2002), Martin (2004), and Feduccia et al. (2005, 2007), the possible avian status of some maniraptorans could reopen the question of avian ancestry outside of Dinosauria, despite Paul's (2002) insistence to the contrary.

In light of these ongoing concerns and the continuing accumulation of new and surprising data from the fossil record, Zhou (2004) argued that abandoning the debate concerning the origin of birds was premature. We concur with this assessment and wish to evaluate the BMT hypothesis in the context of its alternatives. Our goals are (1) to assess whether the BMT has been as critically tested as is claimed in most of the literature and (2) to evaluate alternatives to the BMT hypothesis within a comparative phylogenetic framework, including the possibility that some currently nonavian maniraptorans actually belong within Aves. At a minimum, a simultaneous evaluation of all hypotheses for the origin of birds would allow for the possible refutation

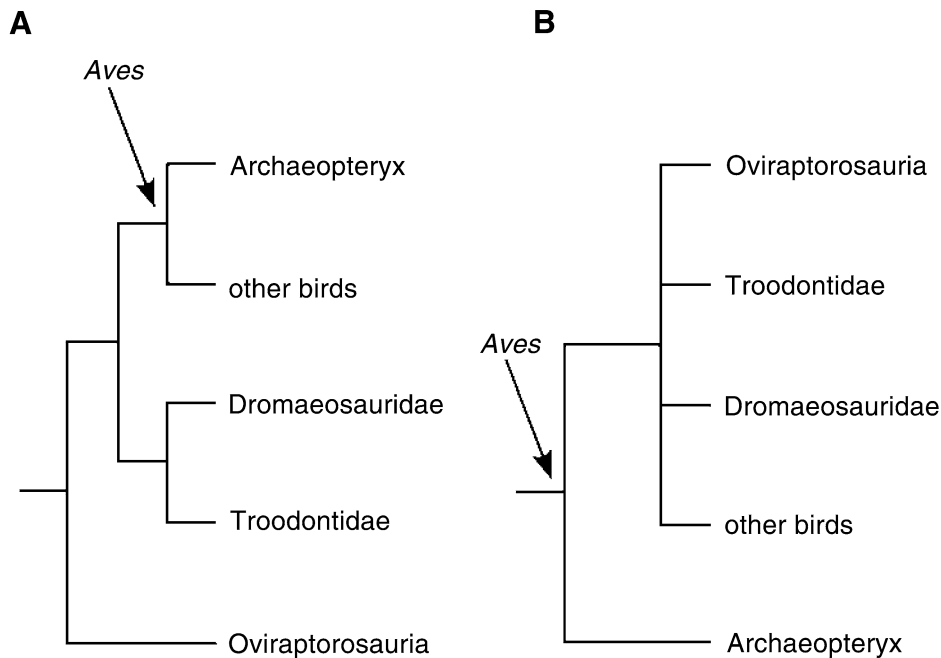

FIG. 1. Alternative relationships of birds and selected maniraptorans. (A) The sister group of Aves is within the maniraptoran theropod dinosaurs as in Figure 2 (the BMT, birds-are-maniraptoran-theropod-dinosaurs topology). (B) Selected maniraptorans are included within Aves.

of the BMT hypothesis. First, we define Aves as used here. Then we describe alternatives to the BMT hypothesis, outline and discuss the analytical methods used here, and present two new analyses. One analysis will be directed toward the first goal of our study, and the other toward the second.

DEFINITION OF AVES

Following Chiappe (1992), Chatterjee (1997), and traditional usage, we define Aves (birds) as a node-based clade that includes *Archaeopteryx*, modern birds, their most recent common ancestor, and all its descendants (Fig. 1A and B). The term “bird” refers to any member of this clade. The term “birdlike” describes any taxon whose morphology is like that of members of the clade Aves. Note that Aves as here defined is equivalent to Avialae *sensu* Gauthier (1986) and other workers (e.g., Perle et al. 1993, 1994; Norell et al. 2001; Clark et al. 2002; Maryańska et al. 2002). Whenever the statement is made that some maniraptorans may have been birds, the topology of Figure 1B is implied, in which these maniraptoran taxa are within the clade

Aves as defined here, rather than the topology of Figure 1A.

THE BMT HYPOTHESIS AND ALTERNATIVES

All authors agree that the origin of birds lies among the Archosauria (*sensu* Benton 1999, 2004; Fig. 2). Archosauria is a clade of diapsid reptiles principally characterized by the presence of the antorbital fenestra in the skull, the lateral mandibular fenestra, and serrated teeth implanted in sockets (Benton 1999, 2004). The osteology of basal archosaurian taxa such as *Proterosuchus* (Cruickshank 1972), *Euparkeria* (Ewer 1965), and *Erythrosuchus* is well understood, though basal relationships are not entirely clear. The crown group of Archosauria is Avesuchia (Benton 1999, 2004), and it includes the Crurotarsi and the Avemetatarsalia. Sereno (1991) argued that crurotarsal archosaurs constitute a monophyletic lineage: they share a rotary ankle with modified calcaneal tubera and condyles, and they lack a mesotarsus (an ankle joint with a simple hinge between the astragalus/calcaneum and the rest of the foot). Ingroup relationships among

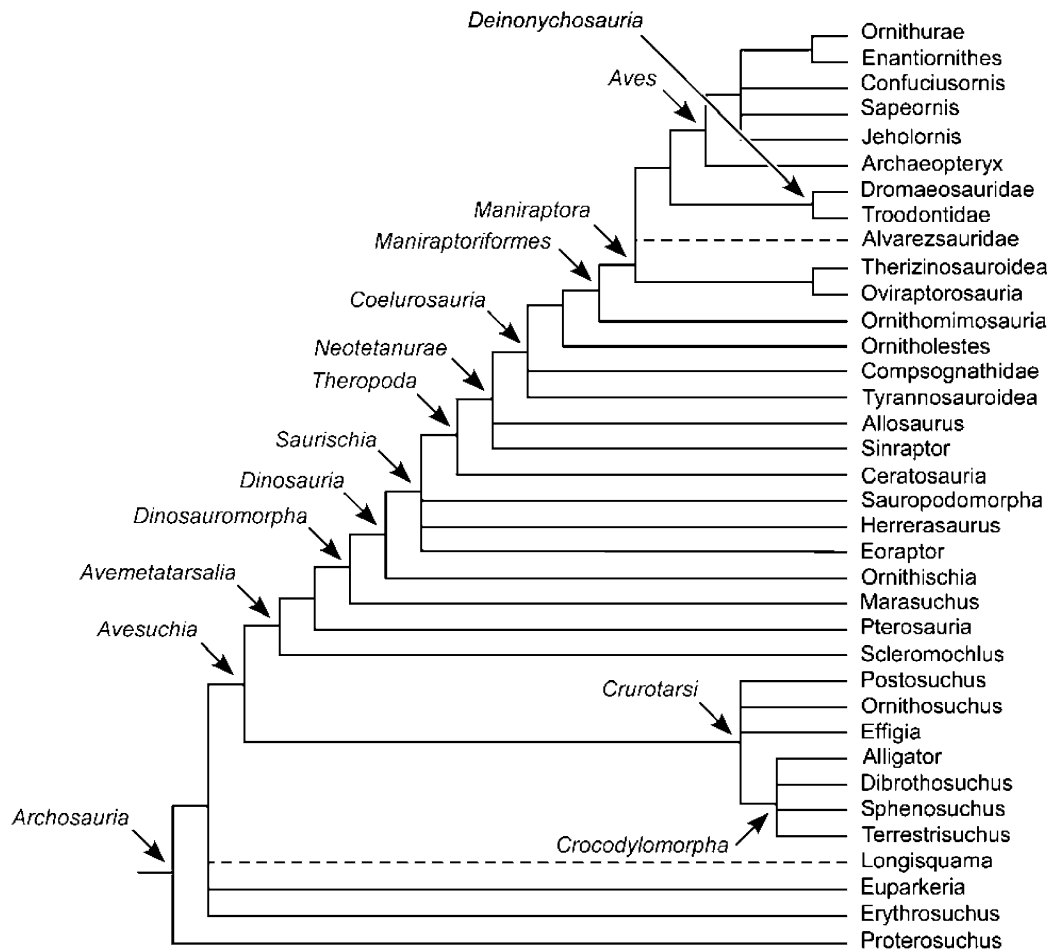

FIG. 2. Generally accepted phylogeny of the Archosauria including the topology of the BMT hypothesis. Based on Clark et al. (2002), Benton (2004), Langer (2004), and Feduccia (2006).

the Crurotarsi are acknowledged to be unclear (Gower and Wilkinson 1996; Benton 1999, 2004), but one major clade within Crurotarsi is the Crocodylomorpha, which includes extant alligators, crocodiles, and gavials. Avernetatarsalians are diagnosed by their well-developed mesotarsus and hind-limb modifications for bipedalism, particularly their elongate tibiae and compact elongate metatarsi with reduced fifth metatarsals (Benton 1999). The present consensus is that the Avernetatarsalia include the Pterosauria and the Dinosauria, including Aves (Benton 1999).

Unfortunately, alternatives to the BMT hypothesis have not been explicitly formulated (e.g., Padian and Chiappe 1998, Padian 2001b, Prum

2003). Before they can be adequately evaluated in a comparative phylogenetic framework, they must be stated explicitly, features of the alternative topology must be identified, and alternative sister taxa with which Aves may be aligned must be specified. In the outline of alternative hypotheses below, and in the analyses reported here, we have taken some of these steps. Five major hypotheses presently address the origin of birds (Fig. 3A–E).

THE BMT HYPOTHESIS

The widely accepted BMT hypothesis (Fig. 3A) states that the sister group of birds lies among the maniraptoran theropod dinosaurs. As noted

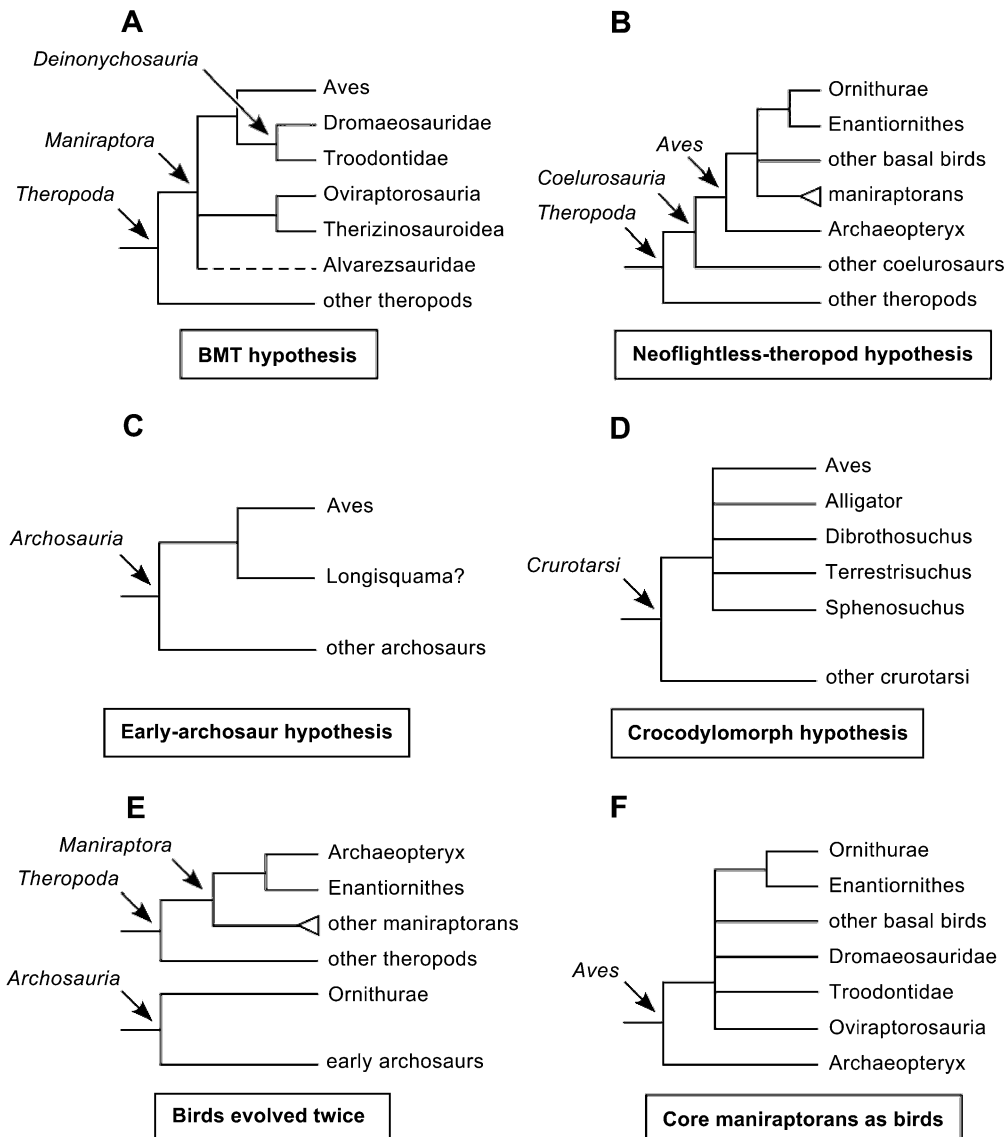

FIG. 3. Five major hypotheses for the origin of birds. (A) The hypothesis that birds are maniraptoran theropod dinosaurs (BMT) and the sister group of birds is the Deinonychosauria (or the Dromaeosauridae) (e.g., Padian 2004). (B) The neoflightless-theropod hypothesis, that the sister group of birds lies among the coelurosaurian theropod dinosaurs but not among the Maniraptora, which are viewed as flightless birds (Paul 2002). (C) The early-archosaur hypothesis, that the sister group of birds is an early arboreal archosaur like *Longisquama* (e.g., Martin 2004). (D) The crocodylomorph hypothesis, for which various topologies have been proposed: a sister-group relationship between birds and crocodylomorphs (represented by *Alligator*, *Dibrothosuchus*, *Terrestriusuchus*, and *Sphenosuchus*) (Walker 1972) and Aves as nested within Crocodylomorpha but branching off before Crocodylia, which is represented by *Alligator*, or with Aves as the sister clade of Crocodylia (Whetstone and Whybrow 1983). The topology shown is a polytomy that could be resolved in favor of any of these topologies. (E) The hypothesis that "birds" evolved twice: one lineage is *Archaeopteryx*, Enantiornithes, and the Maniraptora, and the other is Ornithurae (Kurochkin 2006a, b). Hypotheses B, C, and D include or could include the topology shown in E, that at least three clades of maniraptorans (Dromaeosauridae, Troodontidae, and Oviraptorosauria) were radiations within Aves, whose members were at varying stages of flight loss or flight, as advocated by Czerkas et al. (2002), Feduccia (2002), Paul (2002), Martin (2004), and Feduccia et al. (2005, 2007).

above, the Maniraptora presently include the clades Oviraptorosauria, Troodontidae, Dromaeosauridae, Alvarezsauridae, Therizinosauridae, and Aves. The most birdlike maniraptorans are the oviraptorosaurs, dromaeosaurs, and troodontids, which we will refer to as “core maniraptorans.”

Oviraptorosaurs were small to medium-sized animals with highly specialized skulls that were often ornamented with crests. These skulls were heavily pneumatized and usually toothless. Some oviraptorosaurs had pectoral girdles and forelimbs like those of Mesozoic birds (e.g., *Heyuannia*; Lü et al. 2005), and at least one had a pygostyle (*Nomingia*; Barsbold et al. 2000). The basal oviraptorosaur *Caudipteryx* had unambiguously vaned feathers in a modern arrangement (Ji et al. 1998, Feduccia et al. 2005).

Troodontids were small, gracile predators. The braincases and otic regions of troodontids were exceptionally birdlike (Currie 1985, Currie and Zhao 1993b). Their teeth were similar to those of Mesozoic birds (Currie 1987, Norrell and Hwang 2004). They possessed a large semilunate carpal similar to that of birds (Makovicky and Norell 2004). Unfortunately, troodontid skeletons are poorly represented in the fossil record. At present, no preserved integument has been found with troodontid skeletons.

Dromaeosaurs were small to large predators with birdlike opisthopic pelvises and pectoral girdles with ossified sterna and furculae (Norell and Makovicky 2004). As noted by Ostrom (1969, 1975, 1976a, b), dromaeosaurs also possessed a large semilunate carpal similar to that of birds. The distal caudal vertebrae of dromaeosaurs had characteristic long extensions of the prezygapophyses, a character also seen in the fully flighted Pterosauria. As stated above, the diminutive basal dromaeosaur *Microraptor* was probably arboreal and capable of powered flight (Xu et al. 2003, 2005; Martin 2004; Feduccia et al. 2005, 2007; Longrich 2006; Burnham 2007). The skeletons of all three of the best-known basal dromaeosaurs (*Microraptor*, *Sinornithosaurus*, and *Bambiraptor*) are more similar to those of basal birds than are the skeletons of more derived dromaeosaurs like *Velociraptor* (Paul 2002; Burnham 2004, 2007). For the basal status of *Bambiraptor*, see Burnham (2004, 2007) and the cladistic analysis of Senter et al. (2004). Among specimens of dromaeosaurs, only *Microraptor* possesses unambiguously vaned feathers (Xu et al. 2003; Feduccia et al. 2005, 2007; Longrich 2006); in other taxa, only fibrous

structures are preserved (Xu et al. 1999b, Ji et al. 2001, Norell and Makovicky 2004).

The controversial alvarezsaurids were small cursors with extremely reduced and specialized forelimbs. They were originally placed within Aves as defined here on the basis of characters in the skull, pectoral girdle, and hind limb (Perle et al. 1993, 1994; Chiappe et al. 1998). Recent cladistic analyses have placed them variously as the sister group to Aves (Chiappe 2002a, Chiappe et al. 2002), in a clade with ornithomimosaurids (Sereno 1999, 2001), or basal within the Maniraptora (Norell et al. 2001, Clark et al. 2002, Novas and Pol 2002). Padian (2004) classifies them as basal birds. Small fibrous structures associated with the skeleton of the alvarezsaurid *Shuvuuia* have been identified as feathers by some authors (e.g., Schweitzer et al. 1999, Schweitzer 2001, Paul 2002).

Therizinosaurids were bizarre, ground-sloth-like forms; unlike most other maniraptorans, they were not particularly birdlike, though they had opisthopic pelvises (Clark et al. 2004). Most of them had small skulls with coarsely serrated, lanceolate teeth; vertebrae similar to those of other maniraptorans; and exceptionally long manual unguals. The phylogenetic relationships of therizinosaurids have been contentious, and their affinity with theropods has been questioned (Gauthier 1986, Barsbold and Maryńska 1990), but they are, by consensus, considered theropods (Clark et al. 2004), and the discovery of basal forms like *Falcarius* (Kirkland et al. 2005b) has revealed previously unknown maniraptoran characteristics. Examples are hypapophyses in the presacral vertebrae and the distal placement of the obturator process of the ischium (Kirkland et al. 2005b). The basal therizinosaurid *Beipiaosaurus* (Xu et al. 1999a) was described as possessing simple fibrous structures associated with the skeleton. These have been considered feathers by some authors (Xu et al. 1999a, Clark et al. 2004).

THE NEOFLIGHTLESS-THEROPOD HYPOTHESIS

The “neoflightless-theropod hypothesis” (Fig. 3B) states that the sister group of Aves is an unspecified and hypothetical lineage of arboreal coelurosaurian theropod dinosaurs (Paul 2002, G. Paul pers. comm.). Paul proposes that most and perhaps all of the maniraptoran clades are flightless or flying lineages within the avian radiation, generally according to the topology of Figures 1B and 3E, but he is unsure of the boundaries of Aves,

so the sense in which he considers maniraptorans to be flying or flightless birds is not entirely clear (Paul 2002, G. Paul pers. comm.). To formulate Paul's hypothesis explicitly, we have interpreted his position as generally congruent with the topology of Figures 1B and 3F. His hypothesis is a modification of the BMT hypothesis, in that, although he places the maniraptorans within Aves, he still places both within the Theropoda. Paul (2002) summarized evidence for this hypothesis and presented a tabular, but not a cladistic, analysis of the avian features of maniraptorans.

THE EARLY-ARCHOSAUR HYPOTHESIS

The "early-archosaur hypothesis" (Fig. 3C) states that the origin of birds is more likely to be among early archosaurs than among the theropod dinosaurs (e.g., Tarsitano and Hecht 1980; Feduccia and Wild 1993; Welman 1995; Feduccia 1999, 2002; Czerkas and Yuan 2002; Czerkas et al. 2002; Martin 2004; Feduccia et al. 2005, 2007). As presently understood, this hypothesis includes the propositions that most maniraptorans are flying and flightless lineages within Aves (as in Figs. 1B and 3F) and that they are, in fact, not theropod dinosaurs (Czerkas et al. 2002; Feduccia 2002; Martin 2004; Feduccia et al. 2005, 2007). According to this alternative, the Theropoda as presently constituted are not monophyletic. Aves, including various maniraptorans, is not nested inside Theropoda. Similarities between nonmaniraptoran theropods and birds are accounted for by homoplasy.

Temporally early and phylogenetically basal archosaurs are not a monophyletic group, so a representative lineage or taxon must be designated from among basal archosaurs with which Aves may be aligned. Some candidates, like *Euparkeria* (Broom 1913, Welman 1995), are no longer under consideration (see Gower and Weber 1998). The best-studied current candidate for a potential archosaurian ancestor or sister taxon is *Longisquama*. Sharov (1970) noted similarities to birds in the skeleton and integument of *Longisquama* and suggested that it may be close to avian ancestry. Jones et al. (2000, 2001) described the birdlike osteological characters and the featherlike morphology of the integumentary appendages of *Longisquama*, but the latter was disputed by Prum et al. (2001) and Unwin and Benton (2001). Unwin and Benton (2001) and Senter (2004) questioned the status of *Longisquama* as an archosaur, but its antorbital fenestra (Jones et al. 2000, 2001; Martin 2004; F.

James and J. Pourtless pers. obs.; see Table 1) supports the classification of Sharov (1970) and Jones et al. (2000, 2001). Martin (2004) elaborated on the osteological similarities between *Longisquama* and birds in dentition, characters of the skull, and the presence of a boomerang-shaped furcula similar to that of basal birds. Unfortunately, the pelvic girdle and hind limb are not known. *Longisquama* is best considered a basal archosaur of uncertain affinity (see Fig. 2). Although the type specimen of *Longisquama* is incomplete, it has been described in greater detail than relevant alternatives, and it is the only "early archosaur" that has been explicitly connected with the origin of birds by defenders of the early-archosaur hypothesis. To date, no version of the early-archosaur hypothesis has been evaluated by means of cladistics.

THE CROCODYLOMORPH HYPOTHESIS

The "crocodylomorph hypothesis" (Fig. 3D), first proposed by Walker, states that birds share an immediate common ancestor with Crocodylomorpha (Walker 1972, 1977, 1990), or that the sister group of birds is within the Crocodylomorpha but outside of the Crocodylia, or that Aves is the sister clade of Crocodylia (Martin et al. 1980, Whetstone and Whybrow 1983, Martin and Stewart 1999). Any of these versions of the crocodylomorph hypothesis can be modified to include the proposition that some or all maniraptoran clades belong within Aves (as in the neoflightless-theropod and early-archosaur hypotheses and as depicted in Figs. 1B and 3F), following the current understanding of the early-archosaur hypothesis. We have modified the crocodylomorph hypothesis accordingly. To date, no version of the crocodylomorph hypothesis has been evaluated by means of cladistics.

The crocodylomorph hypothesis has not received much attention in the literature. Walker (1985) recanted it and then later supported it again (Walker 1990). Note that crurotarsal archosaurs underwent an extensive adaptive radiation in the Triassic, and they were far more diverse in the early Mesozoic than they are today (Benton 2004). For example, crocodylomorphs like *Terrestriusuchus* were gracile (Crush 1984), and other noncrocodylomorph crurotarsal taxa, like *Postosuchus* and *Ornithosuchus*, were medium-sized to large forms convergent on theropod dinosaurs. Taxa like *Postosuchus*, *Ornithosuchus*, and *Effigia* were at least facultatively bipedal and had many pelvic-girdle, hind-limb, and cranial characters similar to those

TABLE 1. Taxa included in our analysis and the principal references used for coding their characters.

Taxon	Group	References
<i>Alligator</i>	Crocodylomorpha	Owen (1850), Reese (1915), Mook (1921), Iordansky (1973), personal observation of skulls and postcrania in the collection of the Florida State University Department of Biological Science
<i>Allosaurus</i>	Neotetanurae	Madsen (1993), Chure (2001), Clark et al. (2002), Holtz et al. (2004)
<i>Alxasaurus</i>	Therizinosauroidae	Russell and Dong (1993b), Clark et al. (2002, 2004)
<i>Apsaravis</i>	Ornithurae	Clarke and Norell (2002)
<i>Archaeopteryx</i> ^a	Aves	Walker (1980, 1985), Martin (1985, 1991, 1995, 2004), Elzanowski and Wellnhofer (1996), Elzanowski (2002), Mayr et al. (2005, 2007), personal observation of casts in the collection of the University of Kansas Museum of Natural History (UKMNH)
<i>Avimimus</i>	Oviraptorosauria	Kurzanov (1982, 1983, 1985), Norman (1990), Clark et al. (2002), Maryańska et al. (2002), Vickers-Rich et al. (2002), Osmólska et al. (2004)
<i>Bambiraptor</i>	Dromaeosauridae	Burnham et al. (2000), Burnham (2004), Norell and Makovicky (2004), personal observation of type material and casts at UKMNH
<i>Baptornis</i>	Ornithurae	Martin and Tate (1976), Martin and Bonner (1977), Galton and Martin (2002)
<i>Byronosaurus</i>	Troodontidae	Norell et al. (2000), Clark et al. (2002), Makovicky et al. (2003), Makovicky and Norell (2004)
<i>Caudipteryx</i>	Oviraptorosauria	Ji et al. (1998), Zhou et al. (2000), Padian et al. (2001), Clark et al. (2002), Maryańska et al. (2002), Paul (2002), Osmólska et al. (2004)
<i>Ceratosaurus</i>	Ceratosauria	Madsen and Welles (2000), Tykoski and Rowe (2004)
<i>Citipati</i>	Oviraptorosauria	Clark et al. (1999, 2001, 2002), Osmólska et al. (2004)
<i>Coelurus</i>	Coelurosauria	Carpenter et al. (2005)
<i>Compsognathus</i> ^b	Coelurosauria	Ostrom (1978)
<i>Conchoraptor</i>	Oviraptorosauria	Clark et al. (2002), Osmólska et al. (2004)
<i>Confuciusornis</i>	Aves	Martin et al. (1998b), Chiappe et al. (1999), Hou et al. (1999b), Zhou and Hou (2002)
<i>Deinonychus</i>	Dromaeosauridae	Ostrom (1969, 1974), Clark et al. (2002), Norell and Makovicky (2004)
<i>Dibrothosuchus</i>	Crocodylomorpha	Wu and Chatterjee (1993)
<i>Dilong</i>	Tyrannosauroidae	Xu et al. (2004)
<i>Dilophosaurus</i>	Ceratosauria	Welles (1984), Tykoski and Rowe (2004)
<i>Dromaeosaurus</i>	Dromaeosauridae	Currie (1995), Clark et al. (2002), Norell and Makovicky (2004)
<i>Effigia</i> ^c	Crurotarsi	Nesbitt and Norell (2006)
<i>Enaliornis</i>	Ornithurae	Elzanowski and Galton (1991), Galton and Martin (2002)
<i>Eoenantiornis</i>	Enantiornithes	Hou et al. (1999a), Chiappe and Walker (2002)
<i>Eoraptor</i>	Saurischia	Langer (2004)
<i>Erlikosaurus</i>	Therizinosauroidae	Clark et al. (1994, 2002, 2004)
<i>Erpetosuchus</i>	Crurotarsi	Benton and Walker (2002)
<i>Erythrosuchus</i>	Archosauria	Gower (1997, 2001, 2003)
<i>Euparkeria</i>	Archosauria	Ewer (1965), Gower and Weber (1998)
<i>Falcarius</i> ^d	Therizinosauroidae	Kirkland et al. (2005b)
<i>Gallimimus</i>	Ornithomimosauria	Osmólska et al. (1972), Barsbold and Osmólska (1990), Hurum (2001), Clark et al. (2002), Makovicky et al. (2004)
<i>Gansus</i>	Ornithurae	You et al. (2006)
<i>Guanlong</i>	Tyrannosauroidae	Xu et al. (2006)
<i>Harpymimus</i>	Ornithomimosauria	Makovicky et al. (2004), Kobayashi and Barsbold (2005)
<i>Herrerasaurus</i> ^e	Saurischia	Novas (1993), Sereno (1993), Sereno and Novas (1993), Langer (2004)
<i>Hesperosuchus</i>	Crocodylomorpha	Colbert (1952), Clark et al. (2000)
<i>Heyuannia</i>	Oviraptorosauria	Lü (2002), Lü et al. (2005)
<i>Hongshanornis</i>	Ornithurae	Zhou and Zhang (2005)
<i>Huaxiagnathus</i>	Compsognathidae	Hwang et al. (2004)
<i>Iberomesornis</i>	Enantiornithes	Sanz and Bonaparte (1992), Sanz et al. (2002)
<i>Ichthyornis</i>	Ornithurae	Martin and Stewart (1977), Chiappe (2002a), Clarke (2004)
<i>Incisivosaurus</i>	Oviraptorosauria	Xu et al. (2002a), Osmólska et al. (2004), Senter et al. (2004). Senter et al. (2004) argued that <i>Incisivosaurus</i> is a junior synonym of <i>Protarchaeopteryx</i> , but this argument is not accepted here, and the two taxa are considered distinct.

(continued)

TABLE 1. (Continued)

Taxon	Group	References
<i>Ingenia</i>	Oviraptorosauria	Clark et al. (2002), Lü et al. (2002), Osmólska et al. (2004)
<i>Jeholornis</i>	Aves	Zhou and Zhang (2002, 2003b)
<i>Juravenator</i>	Compsognathidae	Göhlich and Chiappe (2006)
<i>Longisquama</i>	Archosauria	Sharov (1970), Jones et al. (2000, 2001), Martin (2004), personal observation of unpublished photographs of type and casts at UKMNH
<i>Marasuchus</i>	Dinosauromorpha	Sereno and Arcucci (1994)
<i>Microraptor</i>	Dromaeosauridae	Xu et al. (2000, 2003), Clark et al. (2002), Hwang et al. (2002), Norell and Makovicky (2004)
<i>Microvenator</i>	Oviraptorosauria	Makovicky and Sues (1998), Clark et al. (2002), Osmólska et al. (2004)
<i>Mononykus</i>	Alvarezsauridae	Perle et al. (1993, 1994), Clark et al. (2002)
<i>Nothronychus</i>	Therizinosauroidea	Kirkland and Wolfe (2001), Clark et al. (2004), Kirkland et al. (2005a)
<i>Ornitholestes</i>	<i>Incertae sedis</i>	Carpenter et al. (2005)
<i>Ornithosuchus</i>	Crurotarsi	Walker (1964)
<i>Oviraptor</i>	Oviraptorosauria	Clark et al. (2002), Osmólska et al. (2004)
<i>Patagopteryx</i>	Ornithurae	Chiappe (2002a, b), personal observation of cast of MACN-N-11 at UKMNH
<i>Pelecanimimus</i>	Ornithomimosauria	Pérez-Moreno et al. (1994), Clark et al. (2002), Makovicky et al. (2004)
<i>Postosuchus</i>	Crurotarsi	Chatterjee (1985)
<i>Proterosuchus</i>	Archosauria	Haughton (1924), Cruickshank (1972), Clark et al. (1993)
<i>Protopteryx</i>	Enantiornithes	Zhang and Zhou (2000)
<i>Rahonavis</i>	<i>Incertae sedis</i>	Forster et al. (1998), Clark et al. (2002)
<i>Sapeornis</i>	Aves	Zhou and Zhang (2003a)
<i>Saurornithoides</i>	Troodontidae	Clark et al. (2002), Makovicky and Norell (2004). We treated the genus as a composite taxon.
<i>Scleromochlus</i>	Avemetatarsalia	Benton (1999)
<i>Shuvuuia</i>	Alvarezsauridae	Chiappe et al. (2002), Clark et al. (2002), Suzuki et al. (2002)
<i>Sinornis</i>	Enantiornithes	Martin and Zhou (1997), Sereno et al. (2002), supplemented by personal observation of casts of BVP 538a and IVPPV 9769 at UKMNH. Our analysis follows the suggestion of Sereno et al. (2002) that <i>Sinornis</i> and <i>Cathayornis</i> are synonymous.
<i>Sinornithoides</i>	Troodontidae	Russell and Dong (1993a), Currie and Dong (2001), Clark et al. (2002), Makovicky and Norell (2004)
<i>Sinornithomimus</i>	Ornithomimosauria	Kobayashi and Lü (2003), Makovicky et al. (2004)
<i>Sinornithosaurus</i>	Dromaeosauridae	Xu et al. (1999b), Ji et al. (2001), Xu and Wu (2001), Norell and Makovicky (2004). NGMC 91 (Ji et al. 2001) is here considered to be a referred specimen of <i>Sinornithosaurus</i> .
<i>Sinosauropteryx</i>	Compsognathidae	Currie and Chen (2001)
<i>Sinovenator</i>	<i>Incertae sedis</i>	Xu et al. (2002b), Makovicky and Norell (2004)
<i>Sinraptor</i>	Neotetanurae	Currie and Zhao (1993a), Holtz et al. (2004)
<i>Sphenosuchus</i>	Crocodylomorpha	Walker (1972, 1990), unpublished data and private correspondence, provided courtesy of A. Feduccia
<i>Syntarsus</i>	Ceratosauria	Raath (1985), Colbert (1989), Rowe and Gauthier (1990), Tykoski and Rowe (2004). We concur with Paul (2002) in regarding <i>Syntarsus</i> and <i>Coelophysis</i> as nearly identical and therefore probably synonymous.
<i>Terrestriusuchus</i>	Crocodylomorpha	Crush (1984)
<i>Troodon</i>	Troodontidae	Currie (1985, 1987), Currie and Zhao (1993b), Clark et al. (2002), Makovicky and Norell (2004)
<i>Tyrannosaurus</i>	Tyrannosauroidea	Clark et al. (2002), Brochu (2003), Holtz (2004)
<i>Unenlagia</i>	Dromaeosauridae	Novas and Puerta (1997)
<i>Velociraptor</i>	Dromaeosauridae	Norell and Makovicky (1997, 1999, 2004), Barsbold and Osmólska (1999)
<i>Yanornis</i>	Ornithurae	Zhou and Zhang (2001)

^aWe regard *Archaeopteryx* to be monospecific, following Houck et al. (1990), Senter and Robins (2003), and Bennett (2008), as opposed to Elzanowski (2002), Mayr et al. (2005, 2007), and Christiansen (2006).

^bPeyer (2006) came to our attention too late for us to refer to it in scoring *Compsognathus*.

^cNesbitt (2007) came to our attention too late for us to refer to it in scoring *Effigia*.

^dZanno (2006) came to our attention too late for us to refer to it in scoring *Falcarius*.

^eSereno (2007) came to our attention too late for us to refer to it in scoring *Herrerasaurus*.

of dinosaurs (Romer 1956, Walker 1964, Chatterjee 1985, Feduccia 1999, Nesbitt 2007, and references therein). In all cases in which crurotarsal archosaurs developed bipedalism, their pelvic girdles and hind-limb morphology converged on those of avemetatarsalian archosaurs (Romer 1956, Walker 1964, Chatterjee 1985, Feduccia 1999, Nesbitt 2007, and references therein). An excellent example is provided by the morphology of the crurotarsal *Effigia*, which is especially convergent on the morphology of ornithomimosaur and shows further convergence on numerous characters of the avemetatarsalian, dinosaurian, theropod, neotetanurine, and coelurosaurian skeletons (Nesbitt and Norell 2006, Nesbitt 2007).

THE HYPOTHESIS THAT BIRDS EVOLVED TWICE

The hypothesis of Kurochkin (2006a, b) that "birds" evolved twice (Fig. 3E) states that a lineage that includes *Archaeopteryx* and Enantiornithes is nested within Maniraptora, and Maniraptora is nested within Theropoda, but the Ornithurae are aligned with another older, nondinosaurian archosauromorph lineage. Kurochkin's Archosauromorpha are equivalent to Archosauria as defined here (E. Kurochkin pers. comm.). Kurochkin's hypothesis has not been evaluated by means of cladistics.

CLADISTICS

Our cladistic approach follows the recent recommendations of Jenner (2004), who emphasized that great care must be taken in analyzing the comparative morphology of taxa to minimize subjectivity and bias. Jenner insists that all potentially relevant and usable corroborating and disconfirming evidence for all hypotheses under consideration be included in the matrix. Taxon selection should include all currently proposed sister groups, and the matrix should be conservative in the selection and scoring of characters. A conscious effort should be made to minimize *a-priori* assumptions of homology, particularly where the anatomical data are ambiguous. The logical integrity of an analysis would be compromised if statements of homology presupposing particular phylogenetic hypotheses were incorporated into the matrix. Jenner (2004) also insisted that the relationship between the evidence (the matrix) and the optimal tree(s) should be examined with a routine like the bootstrap procedure. Cladistics should be treated not as a way to

test phylogenetic hypotheses but as an exploratory method, useful, if handled sensitively, for comparing and evaluating hypotheses.

METHODS

CONSTRUCTION OF MATRICES

In pursuing our dual goals of (1) evaluating the extent to which the BMT hypothesis has been tested and (2) evaluating the BMT and its alternatives in a single phylogenetic framework, we considered two sets of data. The first is a generally accepted matrix from a recently published paper (Clark et al. 2002) that is representative of the ongoing research of the Theropod Working Group (see Acknowledgments). In this version, which we call the "CNM matrix" (for Clark-Norell-Makovicky), the taxa are 43 theropod dinosaurs and three birds, scored for 208 characters. The intent of Clark et al.'s (2002) study was to examine relationships within the ingroup, which consisted of birds and coelurosaurian theropods. In the CNM matrix, 52% of cells are scored as not applicable or missing data. The matrix includes 40 multistate characters, 13 of which are ordered. We digitized the published matrix to reanalyze it. Evaluation and reanalysis of this typical sample matrix allows evaluation of the support such matrices offer the BMT hypothesis.

To evaluate the BMT hypothesis simultaneously with its alternatives, we reviewed the literature in detail, examined specimens (Appendix 1), and evaluated potential homologies of characters across taxa in a broad array of archosaurs. We then constructed a new 79-taxon \times 221-character matrix. An additional 21 characters were included in an alternative analysis (see below). With the additional 21 characters, our new matrix contains 242 characters. Appendix 2 gives the character list, notes on some of the characters, and their sources; Appendix 3 discusses our reasons for excluding some important characters; Appendix 4 gives the matrix; and Appendix 5 gives comments on scores for certain taxa. To understand our study fully, please consult the appendices.

We included potential sister taxa identified by the hypotheses under test. Poorly known taxa were included if they have figured prominently in discussions of the origin of birds or the phylogeny of birds or if they had to be included because of the limited number of representatives for a particularly important group. Our taxon list consists

of four basal archosaurs, nine crurotarsal archosaurs, two nondinosaurian avemetatarsalians, two basal nontheropod saurischian dinosaurs, 46 theropod dinosaurs (of which 27 were nonavian maniraptorans and 19 were nonmaniraptorans), and 16 Mesozoic birds (Table 1).

Of the 221 characters turned on for the primary analysis of the matrix, 61 are multistate. Twenty of the multistate characters are ordered in all our analyses; included are 5 characters of the integument, 108 characters of the skull, 33 characters of the axial skeleton, and 75 characters of the appendicular skeleton (Appendix 2). Our character states are not polarized (i.e., the zero state is not assumed *a priori* to be the most primitive state for the character). For selection of characters, we used the CNM data matrix as a template. Our matrix shares with the CNM matrix many characters common to other phylogenetic analyses involving theropod or other archosaurian taxa. We retained 96 of their 208 characters verbatim. We excluded characters that had continuous variation (e.g., their character 110), characters that were proportions or that should be formulated as proportions (e.g., their characters 88 and 142), and characters for which we could not understand or detect the variation intended by the authors (e.g., their character 120). Norell et al. (2001) and Clark et al. (2002) used similar criteria in determining which characters to use in their matrices, and both noted that many characters used in the literature are unsatisfactory. Some of the characters in the CNM matrix were designed to address specific questions in coelurosaur phylogeny that were not relevant to our analysis (e.g., their character 156), so they were excluded. We reformulated some characters (e.g., their character 148). Our criteria for excluding characters from the CNM matrix largely match those of Livezey and Zusi (2006).

To be able to evaluate the BMT against alternative hypotheses, we added, in addition to the theropod characters from the CNM matrix, characters from other published analyses that are potential synapomorphies of various nondinosaurian archosaur clades and characters that have been proposed as uniting birds with other archosaur taxa (see references accompanying the character list in Appendix 2). For example, we included dental characters that Martin et al. (1980), Martin (1983, 1991), and Martin and Stewart (1999) suggested might support a close relationship between birds and crocodylians (e.g., our characters 91–95) and braincase and otic-region characters that Walker

(1972, 1990) and Whetstone and Martin (1979) identified as possibly supporting a relationship between birds and crocodylomorphs (e.g., our character 71). We were, however, as critical with respect to these characters as we were with respect to those in the CNM matrix. For example, many of the cranial characters identified by Walker (1972, 1990) as supporting a close relationship between birds and crocodylomorphs were omitted for the same reasons that characters from the CNM matrix were omitted.

Although quantitative characters are important in phylogenetic analysis, obtaining homologous measurements across the broad span of taxa in our matrix was difficult, so the number of quantitative characters had to be minimized. Some important characters of birds that could not be excluded (e.g., our character 170) may best be expressed quantitatively, but we used them as qualitative characters. For treatment of some especially controversial characters, like the metotic fissure, the dentition, the interclavicle, and the furcula, see the notes accompanying Appendix 2.

Following the recommendations of Rieppel and Kearney (2002), Jenner (2004), and Kearney and Rieppel (2006) in constructing our matrix, we tried to minimize making *a-priori* assumptions about the homology of characters across taxa. Primary homology statements that are not independently testable, when used as characters and later regarded as corroborated statements of secondary homology (i.e., synapomorphies; de Pinna 1991), can be misleading. If the data are ambiguous, they lead to unjustified confidence in the phylogeny. If the primary homology statements assume a favored hypothesis, they threaten the analysis with circularity (Rieppel and Kearney 2002, Kearney and Rieppel 2006). Our objective was to create a matrix that, to the extent possible, incorporated characters for which homologies are best supported by the evidence and excluded characters for which homologies rely on the implications of specific hypotheses. Unfortunately, to accommodate the recommendations of Rieppel and Kearney (2002) and Kearney and Rieppel (2006), we had to exclude several major structures from the primary analysis of our matrix. They were included in our matrix but were turned on only for the alternative analysis; see below. Excluded from the primary analysis of our matrix were elements of the palate, the basiptyergoid process, the carpus, the manus, and the tarsus, together accounting for the exclusion of 18 characters (characters 12–15,

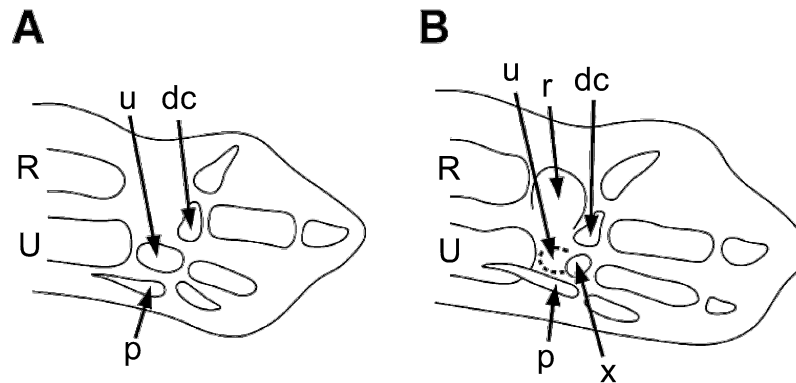

FIG. 4. Embryonic chicken wing bud at (A) 5.5 days of development and (B) 7.5 days of development. Note that in B the regression of the ulnare (indicated by a dashed line) is followed by enlargement of the pisiform, which in later stages of development forms the structure usually, but inaccurately, referred to as the "ulnare" in the adult carpus (e.g., Hinchliffe 1985, Baumel and Witmer 1993; see Kunderát 2008 for an alternative view, described in Appendix 3). Abbreviations: dc = distal carpal, R = radius, U = ulna, u = ulnare, p = pisiform, and r = radiale. Modified from figure 21B, C of Feduccia et al. (2005).

63–65, 148–156, and 196–197) used in the CNM matrix. These ambiguities are summarized in the next paragraph.

The most recent analysis of the avian palate (Livezey and Zusi 2006) concluded that homologies with theropods and other archosaurs are uncertain (see also McDowell 1978). Disagreement arises in the literature on the morphology of the basal avian palate, particularly the morphology of the pterygoid and palatine (compare Elzanowski and Wellnhofer [1996] and Elzanowski [2002] with Mayr et al. [2005, 2007]). Elzanowski (2002) regarded the palate of *Archaeopteryx* as too autapomorphic to permit clear comparisons with other archosaurs, including other Mesozoic birds. A structure homologous with the true basipterygoid process of reptiles is apparently absent in both modern birds and crocodylomorphs, though the underlying cartilages from which a true basipterygoid process would develop are present, which complicates assessments of homology (McDowell 1978, Walker 1990). Carpal homologies among birds, theropods, and other archosaurs are unclear (Hinchliffe and Hecht 1984, Hinchliffe 1985, Feduccia 1999; Appendix 3). Autapomorphic features in the development of the neornithine carpus, such as the disappearance of the ulnare and its replacement by the pisiform (Fig. 4), complicate comparisons with other archosaurs, and theropods in particular (Appendix 3); uncertainties in the identity of the elements of the avian semilunate carpal complicate assessments of homology within Aves, and also between birds

and theropods, in spite of the presence of similar carpals in some maniraptorans. Note that lunate shape is not sufficient to establish homology (see Fig. 5 and Appendix 3). Because the patterns of carpal evolution in theropods are not well understood, comparisons between birds and theropods and between theropods and other archosaurs are difficult (Appendix 3). Moreover, assessment of carpal homologies is largely contingent on resolution of the identities of the manual digits of birds and theropods, which remain contentious (Burke and Feduccia 1997; Feduccia 1999; Wagner and Gauthier 1999; Feduccia and Nowicki 2002; Kunderát et al. 2002; Larsson and Wagner 2002; Galis et al. 2003, 2005; Vargas and Fallon 2005a, b; Welten et al. 2005; see Appendix 3). According to Wagner and Gauthier (1999), manual characters are not necessary for retrieving the consensus BMT topology, which implies that these characters can be excluded without prejudicing an analysis. The homology of the ascending sheet of bone bracing the distal tibia in birds and theropods is unclear (Martin et al. 1980; Martin 1983, 1991; Martin and Stewart 1985; Feduccia 1999). The morphology of this structure is disputed (compare Martin et al. [1980] and Martin [1991] with Mayr et al. [2005, 2007]), and the significance of differences in morphology and development of these structures in birds and theropods (see Fig. 6) is unclear (see Appendix 3 for further details).

Because of the above ambiguities, these five sets of characters cannot be coded for birds and theropods without unjustified assumptions of

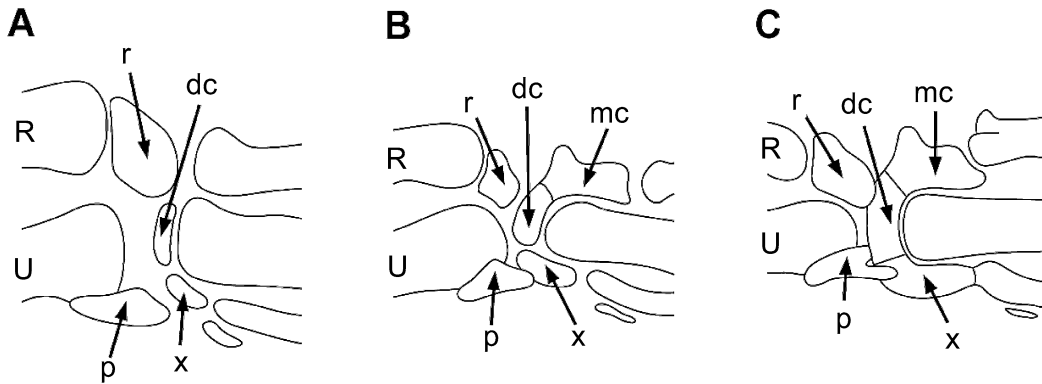

FIG. 5. Carpal cartilages in the chicken wing bud at (A) 9.5, (B) 11.5, and (C) 12.5 days of development. Note the coalescence of the semilunate carpal from the fusion of a distal carpal and element X. The pisiform by 12.5 days of development begins to take on the notched form of the supposed “ulnare” of the adult carpus (see Kundrát 2008 for an alternative view, described in Appendix 3). Abbreviations: mc = metacarpal; all others as in Figure 4. Modified from figures 9–10 of Hinchliffe (1985).

homology. They were not included in the primary analysis of our matrix. This decision is understood to be especially controversial, so we have documented our reasoning, which was based on careful review of the anatomical evidence, in Appendix 3. Nevertheless, to determine whether inclusion of these characters would alter our results, we ran an alternative analysis to evaluate differences made by their inclusion. A total of 21 characters were turned on for the alternative analysis: 1 character for the basipterygoid process, 5 characters of the palate, 14 characters of the carpus and manus, and 1 character of the tarsus (Appendix 2). When these 21 characters were turned on for the alternative analysis, the data matrix contained 242 characters as opposed to 221. Where homologies were uncertain, the added characters were coded as unknown (signified by a question mark) for those taxa.

As part of our effort to be conservative, we scored the controversial integumentary appendages of *Longisquama* as unknown for character 1, the presence of integumentary structures homologous with avian feathers. Overall, we attempted to construct a matrix that satisfies, to the extent possible, the crucial assumption of cladistics, that the scoring of each character can be viewed as an independently testable homology statement (e.g., Rieppel and Kearney 2002, Kearney and Rieppel 2006).

For coding taxa, we relied on the literature and examination of specimens in the collections of the University of Kansas Museum of Natural

History and the Royal Tyrrell Museum. These specimens included casts and original material of theropods and Mesozoic birds (Appendix 1). In spite of some of the common drawbacks of most cladistic analyses, such as counting the absence of a structure as a character state (Jenner 2004), we were not able to avoid the binary coding of the presence and absence of many characters. With the exclusion of the 21 characters turned on in the alternative analysis, 39% of the cells in our matrix were coded as missing data, and 3% as not applicable.

METHODS OF ANALYSIS OF THE MATRICES

We used PAUP*, version 4.0b10 (Swofford 2003), to conduct heuristic searches with both matrices. Heuristic searches for most-parsimonious trees (MPTs) were performed by stepwise addition followed by tree bisection–reconnection (TBR) branch rearrangement, with a maximum tree value of 10,000, as in most of the literature. To select trees for interpretation from among a set of MPTs, we used a combination of bootstrapping, successive pruning of selected taxa, and 50% majority-rule summary trees. For the bootstrapping analyses conducted during analysis of both matrices, 500 pseudoreplicates were generated by fast stepwise addition; groups with a frequency of >50% were displayed on 50% majority-rule summaries of the bootstrapped trees. Such methods estimate the best-supported elements of a tree. This procedure is in agreement with the

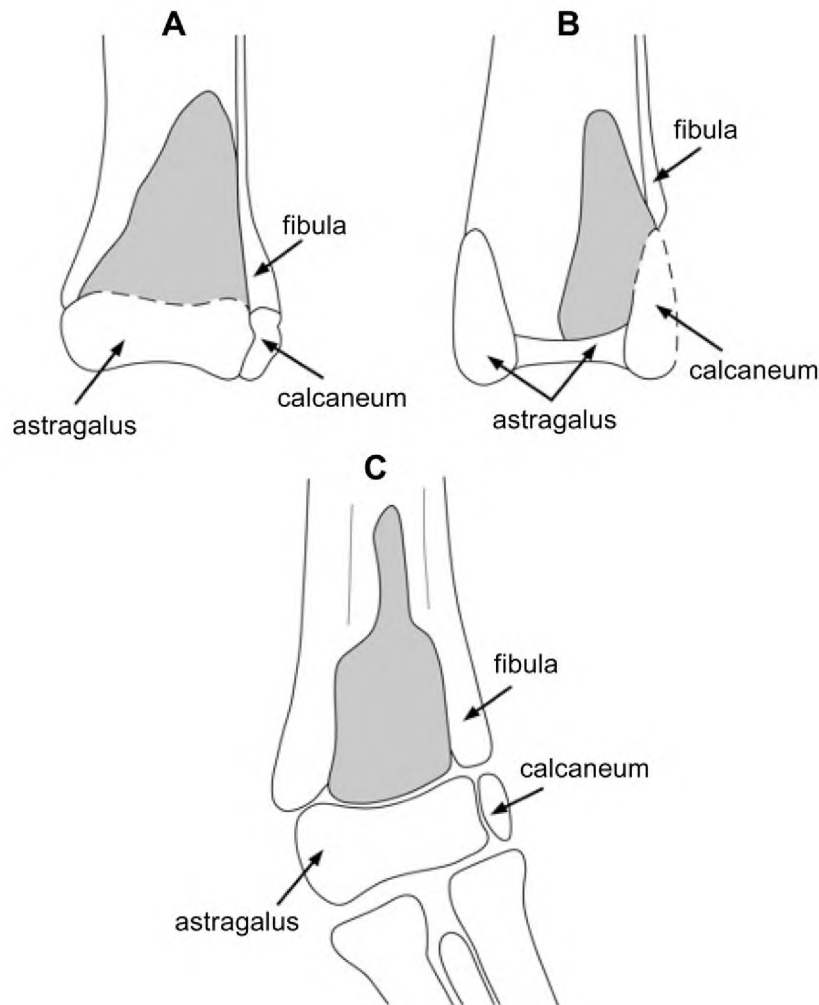

FIG. 6. (A) Distal and proximal tarsals of *Albertosaurus*, (B) a composite of the London and Berlin specimens of *Archaeopteryx*, and (C) the Thermopolis specimen of *Archaeopteryx*. The shaded area represents the "ascending process of the astragalus," the homology of which is unclear across these taxa; in birds it may not be an ascending process of the astragalus at all, but rather a descending pretibial ossification (see Appendix 3). All tarsi are shown in anterior view and are not to scale. Left tarsi are shown in A and B; C depicts the right tarsus reversed to match the orientation of A and B. In C the bones are drawn slightly separated for ease of identification. A is modified from figure 10 of Welles and Long (1974), B is modified from figure 1g of Martin et al. (1980), and C is modified from figure 12b of Mayr et al. (2007).

systematic practices advocated by Wilkinson (1996), Wilkinson and Thorley (2001), Sanderson and Shaffer (2002), Cranston and Rannala (2007), and Holder et al. (2008). We considered reporting a strict consensus of MPTs and adding bootstrap values to it, but we found that our method was able to reveal more statistically supported structure in subsets of the data that addressed particular questions of interest.

Pruning can be an important step for the exploratory analysis of majority-rule trees (Wilkinson 1996, 2003; Steel and Penny 2000; Cranston and Rannala 2007; M. Holder pers. comm.; D. Swofford pers. comm.). It can correct for the negative effects of unstable taxa on tree resolution, especially those taxa with large percentages of missing data. It does not delete taxa from the matrix and does not involve reanalysis; taxa are

pruned from the bootstrapped trees and bootstrap values are recalculated at each pruning to reflect shifts in support when specified taxa are temporarily ignored, and the results are summarized with 50% majority-rule consensus trees. This procedure permits evaluation of the sensitivity of the consensus topology.

Pruning was used in both our reanalysis of the CNM matrix and the analysis of our new matrix. We agree with Wilkinson (1996) and Cranston and Rannala (2007) that, by focusing attention on relationships among exemplar taxa of the groups under consideration, pruning can reveal structure in a tree that would have been obscured by calculation of bootstrap support when all the taxa are taken into consideration. Study of statistical bootstrap support for specific branches on trees can provide useful information, even when the support is low. We initially pruned taxa by percentages of missing data, a procedure similar to the automatic pruning procedures described in the literature by Wilkinson (1996) and Steel and Penny (2000), but we found that this approach was insensitive to the potentially useful information present in some taxa with a high percentage of missing data (see also Kearney 2002, Kearney and Clark 2003). Taking the suggestion of D. Swofford (pers. comm.), we then modified our approach to pruning, basing it on our ability to make predictions and ask specific questions. For example, if the BMT hypothesis is robust, then when maniraptorans are pruned from the tree, Aves should still be nested within a monophyletic Theropoda.

We ran both the CNM matrix and our new matrix with various backbone constraints. This procedure follows recent efforts to place phylogenetic inference in a more statistical framework (Felsenstein 2001, 2004). See Corfe and Butler (2006) for a similar application. Because some of the alternatives to the BMT hypothesis include the proposition that at least some maniraptorans belong within Aves, we tried constraining maniraptoran taxa to be within Aves. Differences in lengths of MPTs were obtained from heuristic searches when topological constraints were enforced, and Kishino-Hasegawa tests (Kishino and Hasegawa 1989) were used to evaluate these differences. In the analysis of our new matrix, results from the application of backbone constraints corresponding to the topologies of the alternative hypotheses of the origin of birds (Fig. 3) were compared, and Kishino-Hasegawa tests were used to evaluate

the differences. The statistical significance of Kishino-Hasegawa tests is reported only to indicate the relative importance of differences among comparisons. Such *a-posteriori* tests are biased toward finding statistical significance, but some of the bias can be controlled if the test is considered to be one-tailed rather than two-tailed, at least when two-tailed *P* values are >0.1 (Goldman et al. 2000). Any remaining bias would still be in the direction of finding statistical significance.

RESULTS

REANALYSIS OF THE CNM MATRIX

Our reanalysis of the 46-taxon \times 208-character CNM matrix using PAUP* allowed the same set of ordered characters as Clark et al.'s (2002). Our heuristic search recovered 356 MPTs of 620 steps. Following Clark et al. (2002) for their strict consensus tree, we rooted our 50% majority-rule summary tree of bootstrap replicates using the theropods *Sinraptor* and *Allosaurus*. In this unpruned tree, birds, maniraptorans, ornithomimosaurids, and other coelurosaurids, except for *Tyrannosaurus* and *Albertosaurus*, appeared in a polytomy with only a few resolved clades (Fig. 7). When the tree was pruned to 24 taxa that represented all the major ingroup clades, however, bootstrap values showed substantial support for the Coelurosauria (75% of bootstrapped trees), Maniraptoriformes (95%), and a clade of birds and maniraptorans (75%) in which internal relationships were largely unresolved (Fig. 8). The Ornithomimosauria (represented by *Struthiomimus* and *Gallimimus*) appeared outside a clade of birds and maniraptorans, as expected. Aves, Dromaeosauridae, Deinonychosauria, and Therizinosauroidea did not appear as clades on the pruned 50% majority-rule tree, though the Oviraptorosauria (72%), Troodontidae (73%), and Alvarezsauridae (100%) were well supported. With further pruning to 18 taxa, Aves and Dromaeosauridae were resolved as two branches of a polytomy including troodontids and oviraptorosaurs (not shown).

When we used backbone constraints to constrain various maniraptoran groups and combinations of maniraptoran groups to be within Aves as defined here, MPTs were only 0–5 steps longer than unconstrained MPTs, increasing from the alvarezsaurids (no difference, equally parsimonious), to the troodontids and dromaeosaurs

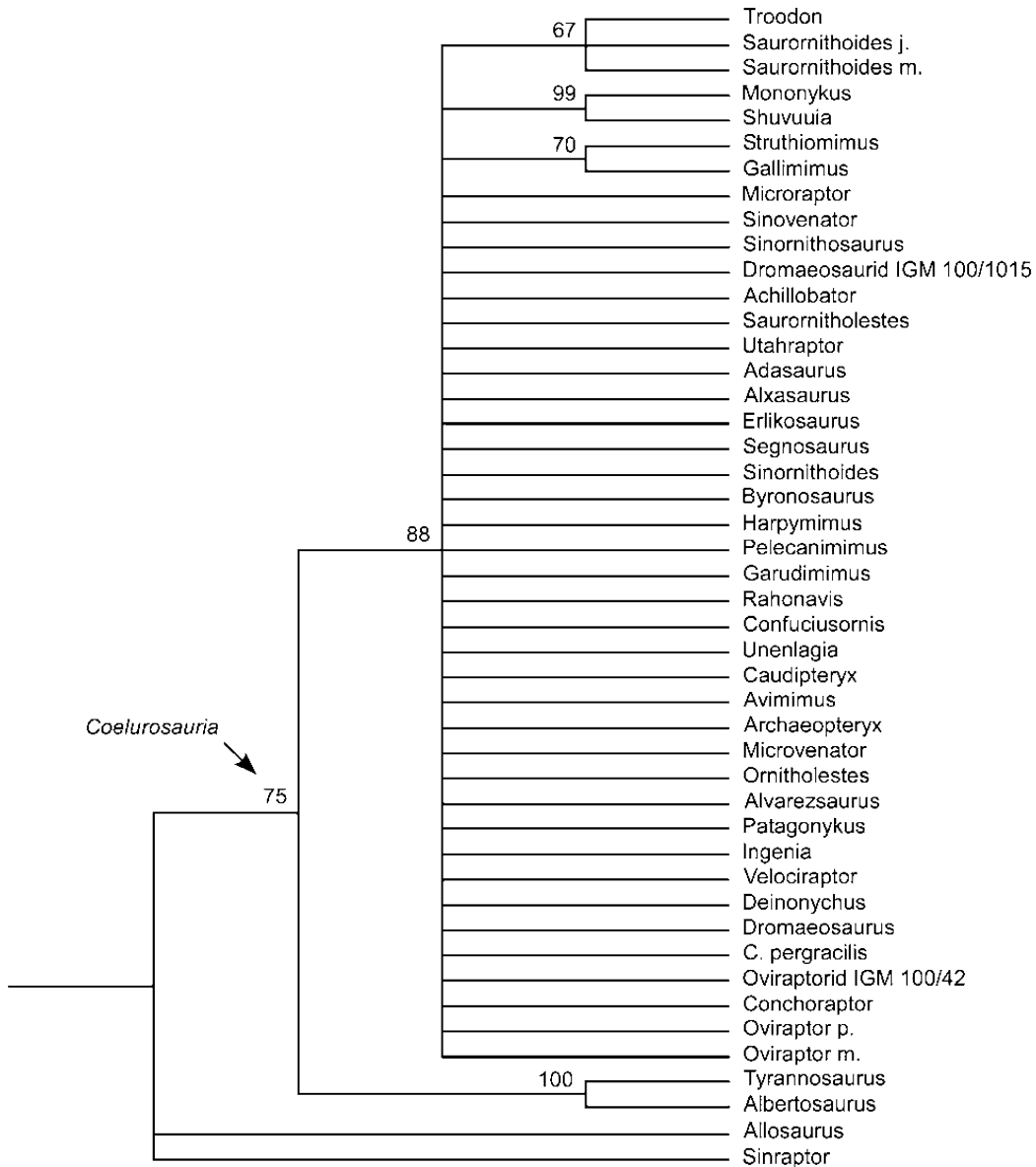

FIG. 7. A 50% majority-rule summary of 500 bootstrap replicates of most-parsimonious trees calculated from the matrix reported by Clark et al. (2002). In this tree, birds, maniraptorans, ornithomimosaur, and other coelurosaurs, except for *Tyrannosaurus* and *Albertosaurus*, appear in a polytomy with only a few resolved clades.

(1 step), to the oviraptorosaurs and therizinosauroids (3 steps), to the combination of oviraptorosaurs, troodontids, and dromaeosaurs (5 steps) (Table 2). An increase to 26 steps in the length of MPTs resulted when the ornithomimosaur were so constrained. The numbers of MPTs increased substantially (to >10,000) with 7 of the 13 various

constraints. Kishino-Hasegawa tests of differences in the lengths of unconstrained MPTs and MPTs resulting from the application of the various constraints are reported as the range of standard deviations among five pairs of randomly selected MPTs, their average *t* value, and the average *P* value for one-tailed tests. The results of the first

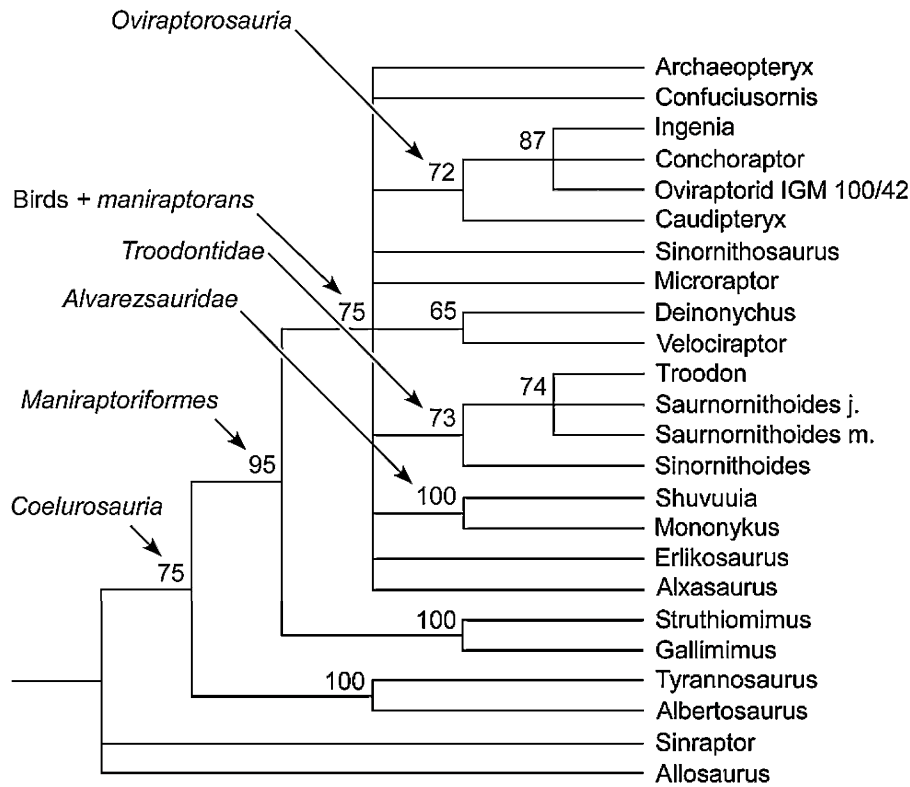

FIG. 8. As in Figure 7, but pruned to 24 taxa that represent all the major ingroup clades of Clark et al. (2002). Bootstrap values show substantial support for the Coelurosauria (75%), Maniraptoriformes (95%), and a clade of birds and maniraptorans (75%) in which internal relationships are largely unresolved. The polytomy of birds and maniraptorans indicates that the interrelationships of birds and maniraptorans are not resolved by our analysis of this data set.

nine tests were not significant. See the asterisk in Table 2 for an explanation of the potential bias in this test.

ANALYSIS OF THE NEW MATRIX

When we analyzed the new 79-taxon \times 221-character matrix without topological constraints using PAUP*, we recovered 360 MPTs of 1,355 steps. We used the basal archosaur *Proterosuchus* for rooting. As with the analysis of the CNM matrix, the unpruned 50% majority-rule summary tree of 500 bootstrap replicate trees had minimal structure, so we pruned away taxa in various ways to ask specific questions with smaller sets of taxa that retained representatives of various combinations of major groups.

First, to explore the relationships among basal birds and representative taxa of the most bird-like core maniraptoran groups (oviraptorosaurs,

troodontids, and dromaeosaurs), we pruned away the other maniraptorans (therizinosauroids and alvarezsaurids) (Fig. 9). With the 20 remaining taxa, Aves was not recovered, but the basal avian taxa (*Archaeopteryx*, *Confuciusornis*, *Sapeornis*) were in a weakly supported clade (58%) with the maniraptorans and *Longisquama*. Interrelationships within this clade were largely unresolved. This clade was in a polytomy with a weakly supported clade of nonmaniraptoriform theropods (66%) and Crocodylomorpha (71%). When birds were pruned away, maniraptorans were still in a weak polytomy with *Longisquama* and were only ambiguously associated with nonmaniraptoran theropods and Crocodylomorpha (not shown). Even when *Longisquama* was pruned away from Figure 9, the clade of birds and core maniraptorans was weakly supported (66%) and was still in a polytomy with a clade of nonmaniraptoran theropods (65%) and Crocodylomorpha (72%) (Fig. 10). Although Aves

TABLE 2. Statistics from reanalysis of the 46-taxon \times 208-character matrix of Clark et al. (2002), with the lengths of most-parsimonious trees (MPTs) when certain theropod taxa were constrained to be within Aves as defined here.

Constraint	<i>n</i>	Missing data (%)	Number of MPTs	Length of MPTs	Difference in length	Kishino-Hasegawa test ^a		
						Range of standard deviations	<i>t</i>	<i>P</i> (one-tailed tests)
None	—	52	356	626				
<i>Shuvuuia</i>	1		347	626	0	—	—	—
Alvarezsauridae	4	61	644	626	0	—	—	—
<i>Microraptor</i>	1	50	10,000	627	1	8.0–8.2	0.125	0.451
Troodontidae	6	55	10,000	627	1	8.0	0.126	0.450
Dromaeosauridae	11	59	10,000	627	1	8.0	0.126	0.450
Dromaeosauridae and Troodontidae	17	58	10,000	627	1	8.0	0.126	0.450
<i>Caudipteryx</i>	1	61	2,424	629	3	8.0–8.2	0.348	0.368
Therizinosauroidae	3	66	10,000	629	3	7.7–8.2	0.373	0.363
Oviraptorosauria	9	56	2,416	629	3	8.0–8.2	0.368	0.368
Oviraptorosauria, Troodontidae, Dromaeosauridae	26	57	1,576	631	5	6.7	0.745	0.229
Maniraptora (no Aves)	33	58	2,048	635	9	7.5	1.193	0.117
Ornithomimosauria	5	52	10,000	652	26	8.9–9.1	2.901	(0.0021)
Maniraptoriformes (no Aves)	38	58	10,000	658	32	10.6	3.029	(0.0014)

Notes: *n* is the number of taxa that were constrained. The consistency index ranged from 0.39 to 0.41; the retention index ranged from 0.66 to 0.69. Comparisons are ordered by the differences in the number of steps in tree length from no constraint (626). Of the 13 comparisons, the first 11 were unable to reject the hypothesis that the trees are sample estimates of the same phylogeny.

^aResults in Tables 2, 3, and 4 are reported as the range of standard deviations and the average *t* and *P* values for five tests between randomly selected topologies between MPTs for no constraint and randomly selected topologies with the stated backbone constraint. Kishino-Hasegawa tests are nonparametric likelihood ratio tests. They give two-tailed tests of differences in topology. We report one-tailed *P* values, which indicate nonrejection of the hypothesis of no difference in the first 11 comparisons. The results also indicate inability to make proper allowance for *a-posteriori* selection of the most-parsimonious trees in the last two comparisons, for which the two-tailed *P* values were less than twice the value required to indicate rejection of the hypothesis of no difference (0.025). Interpretation is also complicated by bias in the test toward finding significant values (Goldman et al. 2000). We therefore put values <0.025 in parentheses.

was weakly supported (53%) on this tree, interrelationships within the clade of birds and maniraptorans were still largely unresolved. When 35 taxa remained, representing all major groups proposed as possible sister-groups of birds (oviraptorosaurs, troodontids, dromaeosaurs, alvarezsaurids, nonmaniraptoran theropods, basal archosaurs, and crocodylomorphs), the cladogram had little structure (Fig. 11). A large polytomy of archosaurs more derived than the basal forms *Proterosuchus*, *Euparkeria*, and *Erythrosuchus* is strongly supported (98%), but neither Aves nor Theropoda is recovered, and birds are not unambiguously closer to theropods than to other archosaurs. When we asked about remaining relationships when the maniraptorans had been pruned away, however, birds were associated with *Longisquama* in a clade (55%) in which interrelationships were largely unresolved

(Fig. 12). This clade of birds and *Longisquama* was in a polytomy with Crocodylomorpha (70%), basal saurischians, and nonmaniraptoran theropods. When *Longisquama* was also pruned away, and 23 taxa remained, Aves was strongly supported (93%) but was still in a polytomy with Crocodylomorpha (71%), basal saurischians, and nonmaniraptoran theropods (Fig. 13).

When various alvarezsaurids, dromaeosaurs, troodontids, or oviraptorosaurs were constrained to be within Aves as defined here (as in Figs. 1B, 3F), MPTs were 3–7 steps longer than unconstrained MPTs, with a jump to 17 steps for therizinosauroids and 23 for ornithomimosaurids (Table 3). Except for the Maniraptora and Maniraptoriformes as a whole, Kishino-Hasegawa tests indicated that the unconstrained and constrained trees were not statistically different.

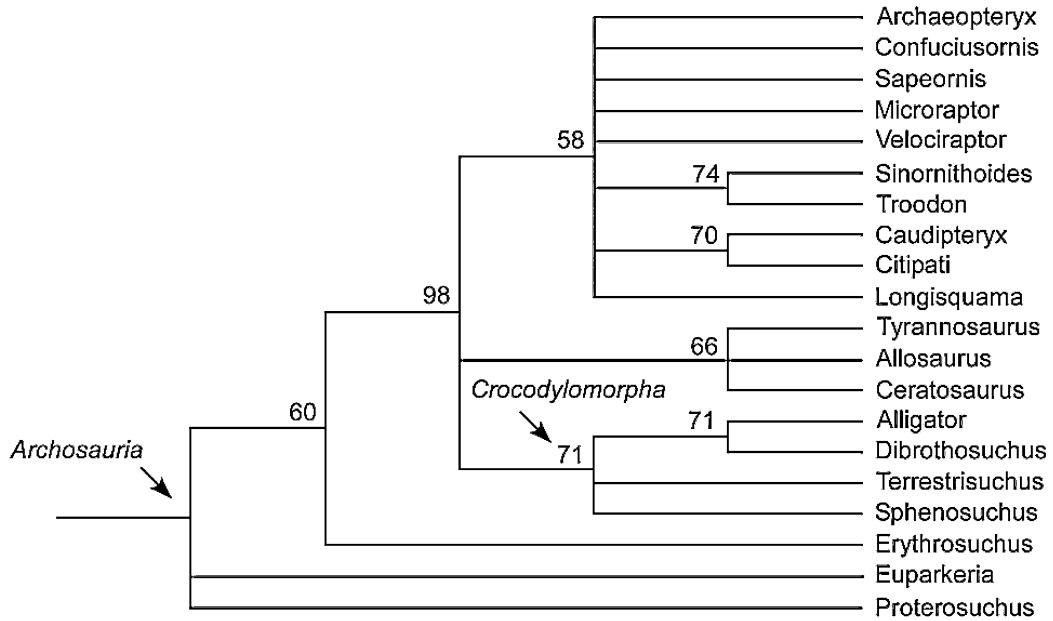

FIG. 9. A 50% majority-rule summary of 500 bootstrap replicates of most-parsimonious trees calculated from a matrix of 79 taxa including theropods, birds, nontheropod dinosaurs, and other archosaurs, pruned to 20 taxa. Pruning reveals a weak clade of birds, core maniraptorans, and *Longisquama* (58%), all in a polytomy with non-maniraptoran theropods (66%) and crocodylomorphs (71%).

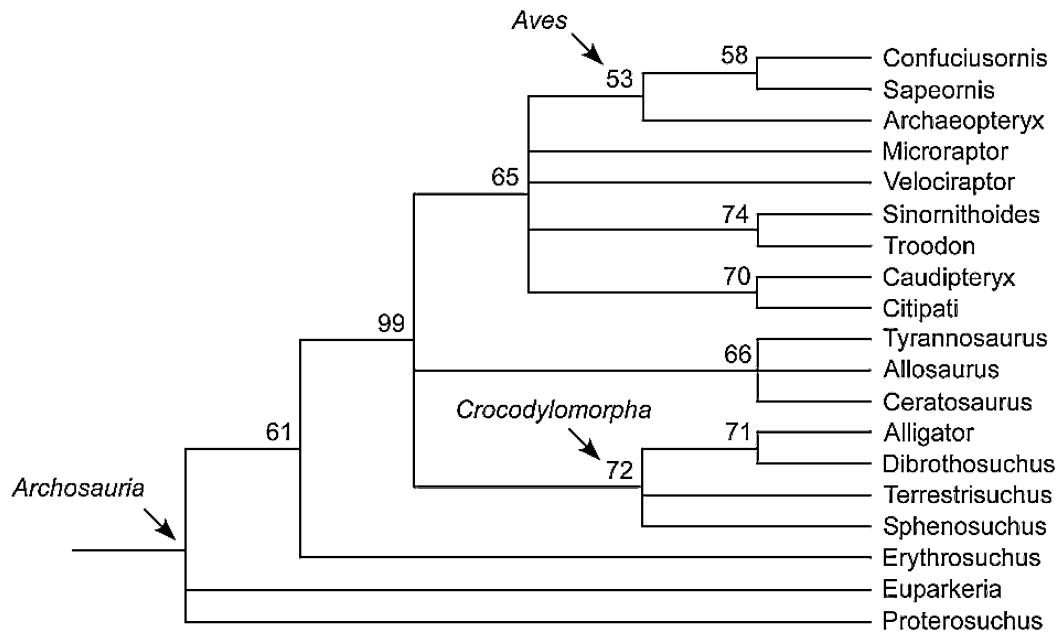

FIG. 10. As in Figure 9, but with *Longisquama* also pruned away. The clade of birds and core maniraptorans has gained support (65%), but it is still not unambiguously closer to other theropods (66%) than to the crocodylomorphs (72%). Even with the removal of *Longisquama*, the relationship of the clade of birds and core maniraptorans to other theropods is ambiguous.

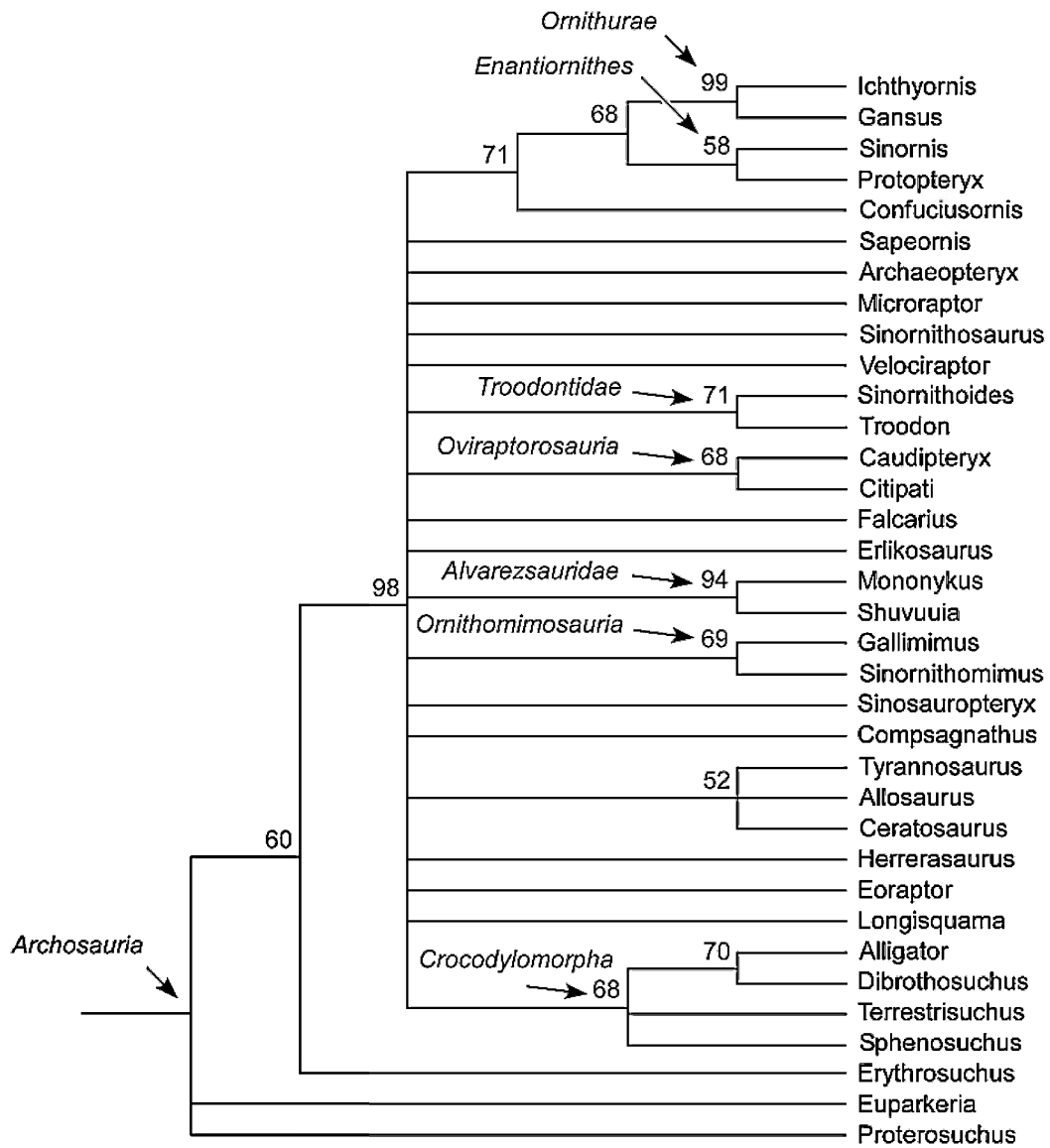

FIG. 11. As in Figure 9, pruned to 35 taxa from 79, representing all major proposed sister groups of birds. There is a large polytomy of archosaurs more derived than the basal forms *Proterosuchus*, *Euparkeria*, and *Erythrosuchus* (98%), in which neither Aves nor Theropoda are recovered and birds are not unambiguously closer to theropods than to other archosaurs.

Next, we repeated our analysis with backbone constraints for the five topologies representing the five hypotheses for the origin of birds (Table 4). Kishino-Hasegawa tests indicated that the early-archosaur, crocodylomorph, and BMT hypotheses were most compatible with the topology

of the MPTs, in that order. The constrained and unconstrained MPTs did not differ significantly. The relative lengths of the MPTs, given their backbone constraints, supported this conclusion (Table 4). The differences were 14, 18, and 27 steps, respectively.

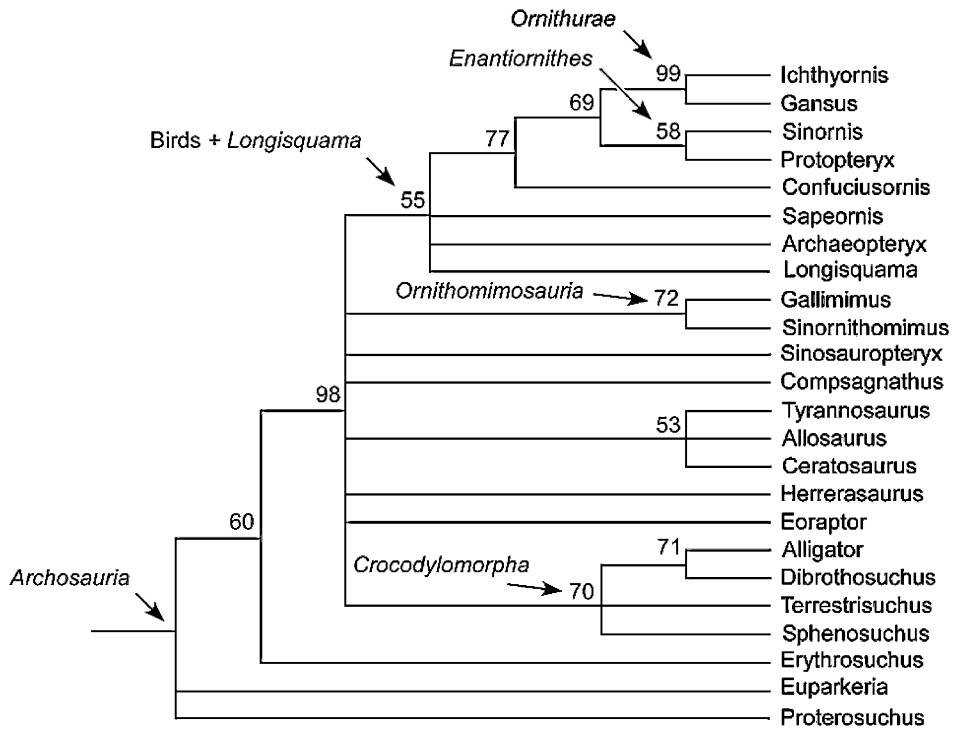

FIG. 12. As in Figure 11, but with the Maniraptora pruned away. Birds are associated with *Longisquama* in a weak clade (55%). That clade is not unambiguously associated with theropods.

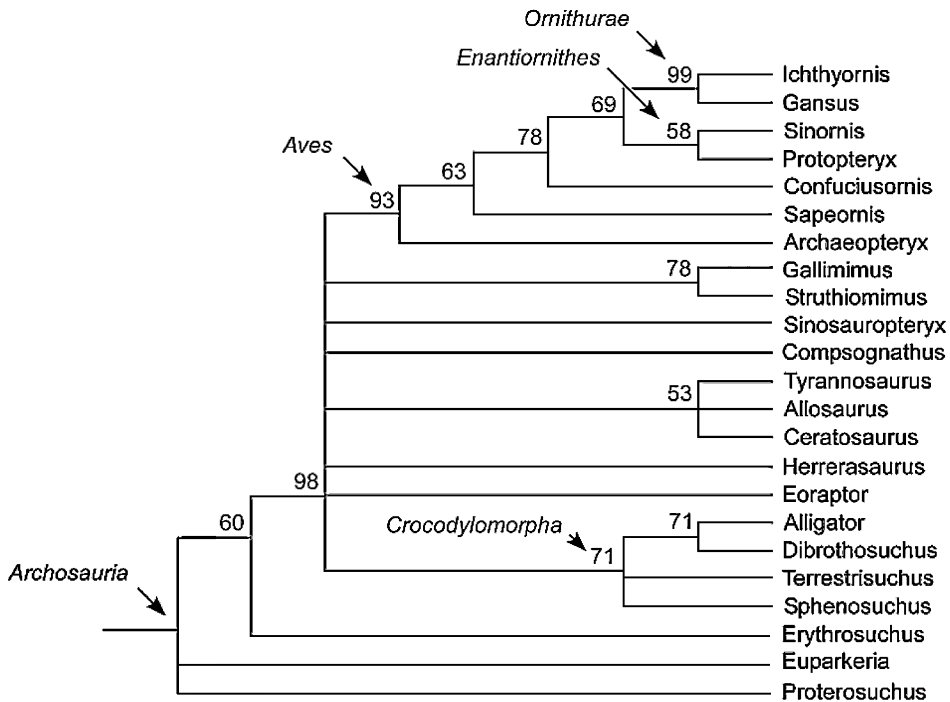

FIG. 13. As in Figure 12, but with both maniraptorans and *Longisquama* pruned away. The sister group of birds is still unresolved. Birds are not clearly more closely related to theropods than to crocodylomorphs.

TABLE 3. Statistics from analysis of our 79-taxon \times 221-character matrix with lengths of most-parsimonious trees (MPTs) when certain theropod taxa were constrained to be within Aves as defined here.

Constraint	<i>n</i>	Missing data (%)	Number of MPTs	Length of MPTs	Difference in length	Kishino-Hasegawa test ^a		
						Range of standard deviations	<i>t</i>	<i>P</i> (one-tailed tests)
None	—	39	360	1,355				
<i>Shuvuuia</i>	1	23	2,169	1,358	3	11.5–13.2	0.245	0.404
Alvarezsauridae	2	43	4,114	1,358	3	12.3–12.6	0.239	0.405
<i>Microraptor</i>	1	41	2,106	1,360	5	11.6–12.5	0.417	0.339
Dromaeosauridae	7	42	2,085	1,360	5	11.8–12.4	0.410	0.339
<i>Caudipteryx</i>	1	37	444	1,360	5	10.1–11.1	0.463	0.267
Troodontidae	5	50	305	1,362	7	11.2–13.2	0.581	0.281
Dromaeosauridae and Troodontidae	12	46	42	1,362	7	10.0–11.3	0.669	0.252
Oviraptorosauria	9	50	192	1,362	7	10.5–11.5	0.643	0.261
Oviraptorosauria, Dromaeosauridae, Troodontidae	21	47	315	1,371	16	10.9–12.2	1.393	0.083
Therizinosaurioidea	4	59	26	1,372	17	13.4–14.1	1.239	0.109
Ornithomimosauria	4	40	2	1,378	23	12.9–13.5	1.738	0.042
Maniraptora (no Aves)	27	49	7,230	1,387	32	13.1–15.0	2.249	(0.013)
Maniraptoriformes (no Aves)	31	48	43	1,392	37	15.1–15.8	2.402	(0.009)

Notes: *n* is the number of taxa that were constrained. The taxa in the full matrix are examples from all archosaur groups proposed to be ancestors of birds, including maniraptoran and nonmaniraptoran theropod dinosaurs, crocodylomorphs, and other nontheropod archosaurs. The consistency index ranged from 0.23 to 0.24. The retention index ranged from 0.62 to 0.64. Comparisons are ordered by differences in the number of steps in tree length from no constraint (1,355).

^aSee note a in Table 2 for interpretation of results.

ALTERNATIVE ANALYSIS OF THE NEW MATRIX

When we analyzed the alternative matrix, with its 79 taxa and 242 characters, without topological constraints (using PAUP*), we recovered 104 MPTs of 1,360 steps. Again, we used the basal

archosaur *Proterosuchus* for rooting. As in the primary analysis, unpruned 50% majority-rule consensus trees displayed minimal structure. After bootstrapping and pruning, the topology of 50% majority-rule consensus trees did not differ appreciably from those reported in Figures 9–13.

TABLE 4. Statistics from analysis of our 79 taxon \times 221 character matrix with lengths of most-parsimonious trees (MPTs) when taxa were constrained to match hypotheses for the origin of birds (BMT = birds are maniraptoran theropod dinosaurs).

Constraint	Number of MPTs	Length of MPTs	Difference in length	Kishino-Hasegawa test ^a		
				Range of standard deviations	<i>t</i>	<i>P</i> (one-tailed tests)
None	360	1,355				
BMT hypothesis	4,624	1,382	27	14.2–15.1	1.864	(0.032)
Neoflightless-theropod hypothesis	52	1,391	36	16.5–17.5	2.137	(0.017)
Early-archosaur hypothesis	12	1,369	14	10.8–11.7	1.237	0.109
Crocodylomorph hypothesis	379	1,373	18	10.9–12.1	1.552	0.061
Birds evolved twice	56	1,441	86	16.1–17.3	5.202	(0.00005)

^aSee note a in Table 2 for interpretation of results.

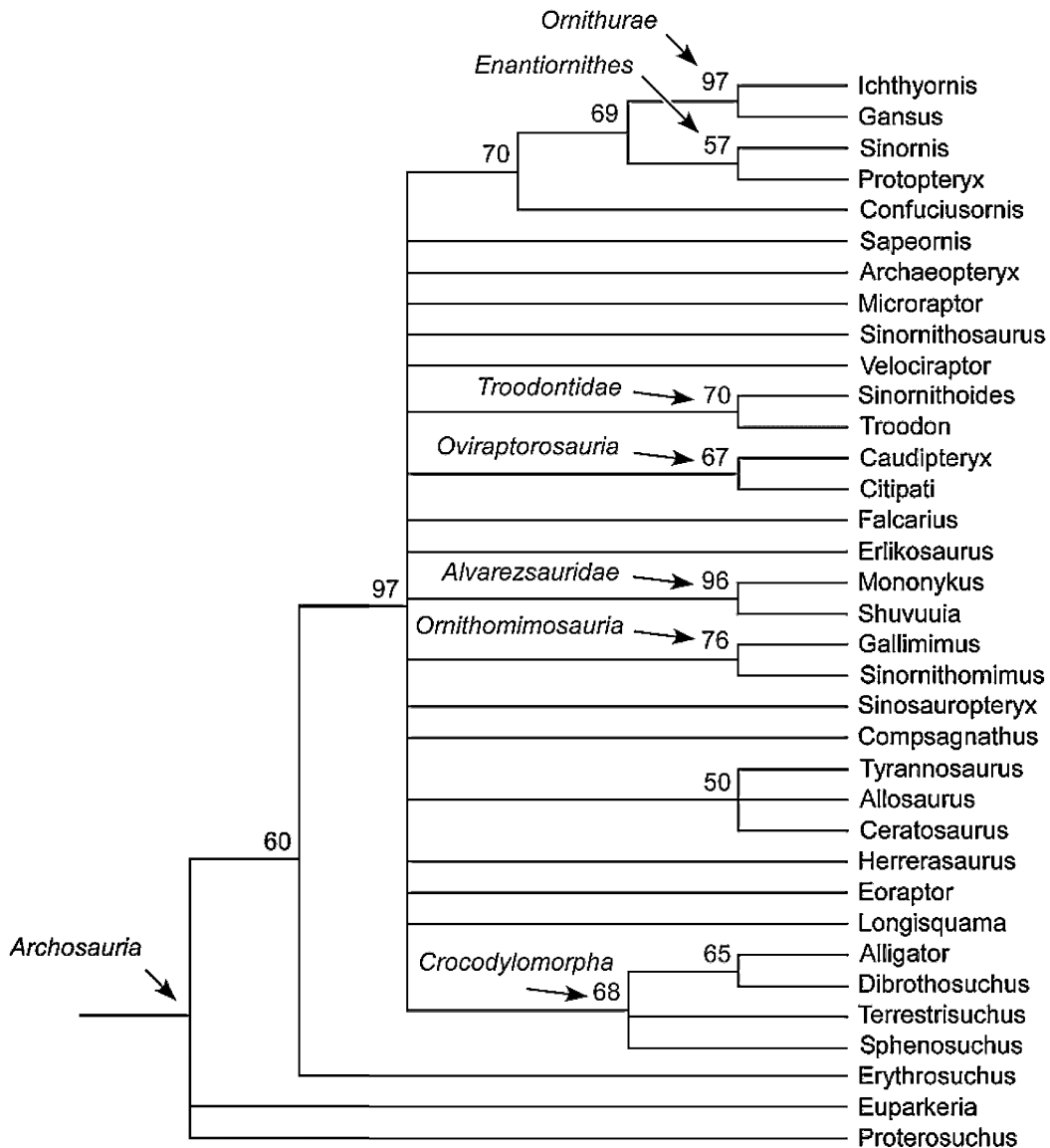

FIG. 14. A 50% majority-rule summary of 500 bootstrap replicates of most-parsimonious trees calculated from an alternative analysis to the analyses reported in Figures 9–13, using 242 instead of 221 characters, and pruned as in Figure 11. Twenty-one characters for questionable homologies, previously turned off, were turned on for this alternative analysis. They were scored as unknown (“?”) where appropriate. Note that the topologies of Figures 11 and this tree are the same and differ only slightly in bootstrap support.

For example, Figure 11, based on the 79×221 matrix, and Figure 14, based on the alternative 79×242 matrix, both have the lowest level of pruning and can be used for the most general comparisons among alternative hypotheses. The topologies do not differ, and only minor differences in bootstrap support were apparent. Of 13

bootstrap values, 11 changes were shifts of only one or two percentage points, and the largest change was a shift of six percentage points for the Ornithomimosauria. Similar comparisons were made for Figures 9, 10, 12, and 13. The only topological differences were in the comparison with Figure 10, where the weakly supported Aves

was not recovered in the alternative analysis, and in the comparison with Figure 12, where the polytomy of basal birds and *Longisquama* was weakly resolved in favor of a sister-group relationship between Aves and *Longisquama*. Again, differences in bootstrap values were negligible.

DISCUSSION

This monograph is a response to defenders of the BMT hypothesis who contend that the BMT hypothesis is correct because no more parsimonious cladistic analysis has been offered by its critics (e.g., Padian 2001b, Prum 2003). We agree that questions about the origin of birds are best viewed in a comparative phylogenetic framework, but logically a hypothesis can be assessed even in the absence of a clearly preferred alternative hypothesis. In any case, here we have taken both approaches. Our study had two goals: (1) to assess whether the BMT hypothesis is overwhelmingly supported by published cladistic analyses and (2) to evaluate the BMT hypothesis in the context of alternatives within a comparative phylogenetic framework, including the proposition that some maniraptorans belong within Aves. Our intention in pursuing the second goal was to allow for possible refutation of the BMT hypothesis. Our review and reanalysis of a representative BMT matrix do not support the contention of BMT advocates either that the hypothesis has been tested with cladistics or that it is overwhelmingly supported. Our cladistic and statistical analyses of our new data set indicate that several predictions derived from the BMT hypothesis are not supported and that alternatives to the BMT are at least equally viable. Altogether, three hypotheses for the origin of birds—the BMT, early-archosaur, and crocodylomorph hypotheses—are most compatible with currently available evidence.

HAS THE BMT HYPOTHESIS BEEN TESTED?

If the BMT hypothesis were as well supported as its proponents claim, a review of the supporting literature and a reanalysis of a representative matrix from that literature should reveal no serious problems, but our review of the literature and reanalysis of data from Clark et al. (2002) revealed (at least) seven problems, which we discuss below: unjustifiable assumptions of homology incorporated into data matrices, inadequate taxon sampling, insufficiently rigorous application of

cladistic methods, insufficient tests of primary homology statements, lack of statistical evaluation, use of verificationist arguments, and introduction of *ad-hoc* auxiliary hypotheses. We conclude that the BMT hypothesis has not been critically tested and that the adoption of a verificationist approach and the introduction of *ad-hoc* auxiliary hypotheses have impaired its testability.

Unjustifiable assumptions of homology incorporated into data matrices.—The most glaring example of this problem is the coding of avian and theropod manual, carpal, and tarsal characters as if they were homologous, despite the ambiguity of the data, and despite the assumption this coding entails that the BMT hypothesis is correct *a priori* (Martin et al. 1980; Martin 1983, 1991; Martin and Stewart 1985; Burke and Feduccia 1997; Feduccia 1999; Wagner and Gauthier 1999; Feduccia and Nowicki 2002; Kundrát et al. 2002; Larsson and Wagner 2002; Galis et al. 2003, 2005; Mayr et al. 2005, 2007; Vargas and Fallon 2005a, b; Welten et al. 2005; Appendix 3). This practice conflicts with the recommendations of Rieppel and Kearney (2002) and Kearney and Rieppel (2006) about ways to avoid the dangers of incorporating unjustifiable assumptions of homology into data matrices. Unfortunately, these problems persist even in the improved matrices of the Theropod Working Group, like the CNM matrix of Clark et al. (2002). For example, Clark et al. (2002) used manual characters scored for both birds and theropods, thereby assuming their homology. In addition to the importation of bias through unjustified assumptions of homology, the current BMT literature, like much literature in morphological cladistics, does not provide rigorous analysis of characters. Ambiguities in the data that complicate assessment of primary homologies are usually not addressed in the current BMT literature (see Appendix 3 for detailed analyses of some problematic characters).

The congruence of other characters is sometimes offered as justification for such assumptions: birds are theropods because they share other characters with theropods and, therefore, must have the same digital identities as theropods (e.g., Wagner and Gauthier 1999, Makovicky and Dyke 2001, Padian 2001b). This reasoning is circular. Synapomorphies are invoked to defend the hypothesis; the hypothesis is invoked to defend the synapomorphies.

Inadequate taxon sampling.—Like the CNM matrix, all analyses we could find that were cited as supporting the BMT hypothesis failed to include

nondinosaurian taxa. Such analyses cannot test the BMT hypothesis, because they do not allow for the possibility of its refutation. At best, they are attempts to examine the interrelationships of birds and theropods, once Aves is assumed to be nested inside Theropoda.

Insufficiently rigorous application of cladistic methods.—Clark et al. (2002) used the program NONA (Goloboff 1999) to perform a heuristic search for unrooted MPTs. They used branch swapping extended to suboptimal trees up to 10% longer, retrieved MPTs, and then calculated consistency and retention indices. They then computed a strict consensus of the MPTs and rooted it, in this case with the noncoelurosaurian theropods *Allosaurus* and *Sinraptor* (Clark et al. 2002, fig. 2.2A). No further tree evaluation, such as the bootstrap procedure, was reported, and the strict-consensus tree was taken as a well-supported reconstruction of the phylogeny of the ingroup taxa. Except in a few recent papers (e.g., Maryańska et al. 2002), the methods used by Clark et al. (2002) are typical of the methods employed throughout the BMT literature.

As emphasized by Felsenstein (2004) and others, proper rigor requires searching for relationships supported by a known proportion of trees and determination of what subset of relationships among the population of trees is well supported, rather than searching for the optimal tree and then assuming that it is the correct phylogeny from which character evolution can reliably be reconstructed. Failure to assess the relationships between the evidence (the matrix) and the hypothesis (the cladogram) with procedures like the bootstrap, and the assumption that a strict consensus tree accurately reflects supported relationships, are serious deficiencies in much of the literature in systematics (Swofford et al. 1996, Felsenstein 2004, Jenner 2004).

Pruning used in combination with bootstrapping can further enhance comparisons between the evidence and the hypotheses being evaluated. Through successive pruning, one can attempt to determine how specific taxa affect support for branches as revealed by bootstrap analyses (Wilkinson 1996). Therefore, pruning is useful in exploratory analyses of subsets of the data and allows for more sensitive estimation of support for branches in 50% majority-rule trees (Wilkinson 1996, 2003; Steel and Penny 2000; Cranston and Rannala 2007; Holder et al. 2008). We used bootstrapping and successive pruning and reported

our results on 50% majority-rule trees. The combination of bootstrapping and pruning used in our reanalysis of the CNM matrix, and in the analysis of our new matrix, revealed structure in the data and in subsets of the data for which some estimates of statistical support could be made.

As was the case in our reanalysis of the CNM matrix, high resolution on a strict-consensus tree can prove to be spurious when bootstrapping and pruning are used to evaluate support for the consensus topology. Our reanalysis revealed that the structure of the strict consensus tree of Clark et al. (2002) has minimal statistical support. A transfer of bootstrap values from the 50% majority-rule summary of the bootstrap replicates (Fig. 7) to the strict consensus tree reported by Clark et al. (2002) would have revealed that almost none of the clades reported on that tree have $\geq 50\%$ bootstrap support. Interestingly, although Clark et al.'s (2002) strict consensus tree recovers Aves deeply nested within Maniraptora, bootstrapping combined with pruning reveals that the relationships among the maniraptoran and avian taxa are actually unresolved (Figs. 7 and 8), leaving open the possibility that some maniraptoran taxa belong within Aves. Given the importance of the relationship between birds and maniraptorans in the debate about the origin of birds, this previously overlooked ambiguity is significant. This lack of resolution indicates uncertainties in the cladistic support for the BMT hypothesis that have rarely been acknowledged.

Of course, our methods are not without their own deficiencies. Although bootstrapping was used in our study, bootstrap values only give an indication of the strength of support for a branch and should, therefore, be interpreted cautiously (Swofford et al. 1996). Although Swofford et al. (1996) recommended weighting characters and creating step matrices as ways to incorporate independent data, we did not use these options. We felt that selection of weights and step matrices was as likely to add bias to the analysis as to reduce it. Neither did we evaluate the relationship between character conflicts and missing data (Kearney 2002, Kearney and Clark 2003).

Insufficient tests of primary homology statements.—Given its problems in dealing with homoplasy (e.g., Gosliner and Ghiselin 1984; Carroll 1988; Carroll and Dong 1991; Livezey 1998, 2003; Feduccia 1999; Wiens et al. 2003), cladistics alone should not be relied upon to test phylogenetic hypotheses, and “tests of congruence” should

not be relied upon to evaluate primary homology statements (Rieppel and Kearney 2002, Kearney and Rieppel 2006). Independent testability of primary homology statements should be grounded in comparative anatomical research (Rieppel and Kearney 2002, Kearney and Rieppel 2006). Even though a cladistic analysis does not actually test a hypothesis—it simply produces the most parsimonious phylogeny, given the assumptions incorporated into the analysis *a priori*—many have claimed that the BMT hypothesis has been tested with cladistics (e.g., Padian and Chiappe 1998; Padian 2001b; Prum 2002, 2003).

Lack of statistical evaluation.—Recent efforts to introduce statistical methods into phylogenetic analyses (e.g., Felsenstein 2001, 2004) offer additional techniques for strengthening evaluation of phylogenetic hypotheses. Unfortunately, the BMT literature continues to interpret cladistic results without statistical evaluation.

Verificationist arguments.—The BMT hypothesis has been claimed to be overwhelmingly supported by the many synapomorphies shared by birds and theropods (e.g., Padian and Chiappe 1998; Chiappe and Dyke 2002; Paul 2002; Prum 2002, 2003; Xu et al. 2003; Xu 2006). The hypothesis is inferred to be correct because of the vast quantity of data held to support it. This argument is logically problematic. The number of confirmatory observations that a hypothesis can marshal is not necessarily relevant to whether the hypothesis is correct, and the history of science offers numerous examples of “overwhelmingly supported” theories that were later refuted (Hempel 1966; Popper 1998, 2002). The risk is that only supporting evidence will be recognized, while contradictory evidence is ignored or explained away. Kluge (1997, 1999, 2001) has repeatedly urged the adoption of a falsificationist, rather than a verificationist, research program for cladistics.

Logic aside, criticism of putative synapomorphies shared by birds and theropods has persisted. In particular, inferences of homologies for characters of the carpus, manus, and tarsus have been questioned (e.g., Burke and Feduccia 1997; Feduccia 1999, 2002; Feduccia and Nowicki 2002; Martin 2004; Feduccia et al. 2005, 2007; see Appendix 3). One prominent reply to these concerns is to appeal to the reasoning outlined above (e.g., Wagner and Gauthier 1999, Makovicky and Dyke 2001, Padian 2001b), arguing that the preponderance of confirming data allows any given falsifying observations to be discounted. However,

provided that the observation is repeatable—and, thus, not attributable to a flawed experiment or faulty observation (see Popper [2002] on the necessity of repeatability)—logic dictates that even a single observation could be enough to falsify the BMT hypothesis if it contravenes a prediction logically deducible from that hypothesis. Consequently, the verificationist approach is neither logically nor empirically sound. It has discouraged critical evaluation of the BMT hypothesis and encouraged the uncritical practice of looking only for supporting evidence.

Introduction of ad-hoc auxiliary hypotheses.—An *ad-hoc* auxiliary hypothesis is one that has been formulated for the specific purpose of restoring agreement between a hypothesis and falsifying observations; it serves no independent explanatory function and does not entail any significant, independently testable implications (e.g., Hempel 1966, Popper 2002). Although *ad-hoc* auxiliary hypotheses are often used to protect favored hypotheses (Kuhn 1970), and although they may be empirically valid, they actually interfere with testability (Hempel 1966, Popper 2002) by increasing the range of observations with which a hypothesis is compatible. If the introduction of *ad-hoc* auxiliary hypotheses were considered legitimate, they could be used to explain away all falsifying observations, rendering a favored hypothesis immune to any criticism. Repeatedly obtained observations that contradict a hypothesis should be accepted as falsifying observations rather than explained away.

The “frame-shift hypothesis” of Wagner and Gauthier (1999) is an example of an *ad-hoc* auxiliary hypothesis. The tridactyl manus of neotetanurine theropods appears to be composed of the first, second, and third digits of the primitively pentadactyl archosaurian manus (e.g., Gauthier 1986, Wagner and Gauthier 1999; see Appendix 3), which implies that, if Aves is nested within Theropoda, the digits of the tridactyl avian manus should be digits I, II, and III. Embryological data indicate, however, that the digits of the avian manus are in fact the second, third, and fourth digits of the primitively pentadactyl archosaurian manus (e.g., Feduccia 2002, Feduccia and Nowicki 2002, Kunderát et al. 2002, Larsson and Wagner 2002; see Appendix 3). This repeatedly obtained observation contradicts a key prediction of the BMT hypothesis and is logically sufficient to refute it. To explain away this falsifying observation, Wagner and Gauthier (1999) proposed

that a homeotic frame-shift affecting digital identity must have occurred during the evolution of neotetanurine theropods (see Appendix 3).

Although some data suggest that homeotic frame-shifts such as those postulated by Wagner and Gauthier (1999) can occur in vertebrate evolution, and perhaps occurred during theropod evolution (e.g., Vargas and Fallon 2005a, b, and references therein), these data do not alter the logical status of the frame-shift hypothesis as an *ad-hoc* auxiliary hypothesis (for a review of the data, see Appendix 3). It was introduced for the explicit purpose of restoring agreement between predictions of the BMT hypothesis and repeatedly obtained falsifying observations. It explains no previously unexplained data in theropod or avian evolution and generates no new, significant, testable predictions that might enhance the overall testability of the BMT hypothesis. As an *ad-hoc* auxiliary hypothesis, the frame-shift hypothesis restricts the range of observations that could contravene the BMT hypothesis and interferes with its testing.

Göhlich and Chiappe (2006) provide another example. Feathers are hypothesized to be a synapomorphy of at least the Coelurosauria (e.g., Chiappe and Dyke 2002, Norell and Xu 2005), because of the identification of fibrous structures in basal coelurosaurs like the compsognathid *Sino-sauropteryx* (Currie and Chen 2001) as feathers. The prediction that any fossil of a coelurosaurian taxon with large tracts of well-preserved integument should display feathers can be logically deduced from this hypothesis. Consequently, the discovery of a coelurosaurian fossil with well-preserved integument lacking feathers would be logically sufficient to falsify the hypothesis that all coelurosaurs were feathered, a key component of the BMT hypothesis itself. The compsognathid *Juravenator*, described by Göhlich and Chiappe (2006), is exquisitely preserved, and the type material includes large tracts of well-preserved integument. Nevertheless, no feathers are preserved in the *Juravenator* type material. Göhlich and Chiappe (2006) explained away this falsifying observation by postulating four distinct *ad-hoc* auxiliary hypotheses: (1) feathers evolved repeatedly in Coelurosauria, accounting for discrepancies in feather distribution among well-preserved coelurosaurian taxa; (2) some coelurosaurs, like *Juravenator*, secondarily lost their feathers; (3) unspecified and unknowable autapomorphic features in compsognathid ontogeny produced

aberrant distribution of feathers in this clade; and (4) regional climatic variation produced variation in distribution of feathers among compsognathids.

Like the frame-shift hypothesis of Wagner and Gauthier (1999), these four hypotheses were introduced for the explicit purpose of restoring agreement between a prediction that is a key component of the BMT hypothesis and an unambiguously falsifying observation. Although any one of these four hypotheses could be correct, none of the four explains previously unexplained data in theropod or avian evolution or generates any new, significant, testable predictions that might enhance the overall testability of the BMT hypothesis. Like the frame-shift hypothesis, they are *ad-hoc* auxiliary hypotheses that restrict the range of observations that could contravene the BMT hypothesis and interfere with its testing.

EVALUATION OF ALTERNATIVE HYPOTHESES

Although we think that the BMT hypothesis has not been tested and is not as overwhelmingly supported as has been claimed, it is not, for those reasons, necessarily incorrect. Analysis of our new matrix, however, which allows for evaluation within a comparative framework of the BMT hypothesis and four alternative hypotheses for the origin of birds (Fig. 3), and review of the literature, indicate (1) that several predictions derivable from the BMT hypothesis are not supported; (2) that some maniraptorans may belong within Aves, which potentially supports the three alternatives to the BMT hypothesis that incorporate this topology (the neoflightless-theropod hypothesis, the early-archosaur hypothesis, and the crocodylomorph hypothesis); (3) that avian status for even some maniraptorans weakens support for both the BMT hypothesis and the neoflightless-theropod hypothesis; and (4) that, of the alternatives to the BMT hypothesis, the early-archosaur and crocodylomorph hypotheses are equally compatible with currently available evidence. We expand on these points below.

Are predictions of the BMT hypothesis supported by our results?—We derived several predictions from the BMT hypothesis and checked to determine whether they were supported by our analyses (see Table 5). For example, the BMT hypothesis holds that Aves is deeply nested within the Maniraptora and that maniraptoran clades like the Oviraptorosauria, Dromaeosauridae, and Troodontidae are

TABLE 5. Five predictions of the BMT (birds are maniraptoran theropod dinosaurs) hypothesis, along with indications from the present analysis of the Clark et al. (2002) matrix for coelurosaurs and of our matrix, in which all hypotheses can be evaluated simultaneously.

Prediction of the BMT hypothesis	Indications of support from the Clark et al. (2002) reanalysis	Indications of support from analysis of our matrix
The lengths of most-parsimonious trees and those of trees in which various nonavian maniraptorans are constrained to be within Aves as defined here will differ statistically.	No (Table 2)	No (Table 3)
In cladograms, Aves will be nested within the Maniraptora. A clade of birds and maniraptorans will be nested within the Theropoda.	Ambiguous (Fig. 8) Yes (Fig. 8)	Ambiguous (Figs. 9–11) No (Figs. 9–11)
When potential sister groups for birds among early archosaurs are pruned away, a clade of birds and maniraptorans will be clearly associated with theropods.	—	No (Fig. 10)
When maniraptorans are pruned away, birds will be clearly associated with theropods instead of with early archosaurs or crocodylomorphs.	—	No (Figs. 12 and 13)

nonavian. Consequently, in both the reanalysis of the CNM matrix and the analysis of our new matrix, the lengths of unconstrained MPTs and trees in which various maniraptorans are constrained to be inside Aves should differ statistically. When the backbone-constraint options in PAUP* and the Kishino-Hasegawa tests were used, and the warnings of Goldman et al. (2000) about such applications were accommodated, this prediction failed both with the CNM data (Table 2) and with ours (Table 3). The concerns of Goldman et al. (2000) were about bias toward finding statistical differences, not toward the small, nonsignificant differences that we found. These results conflict with what would be expected if the BMT hypothesis were correct. They indicate that a topology in which at least some maniraptorans are actually birds cannot be rejected as statistically significantly worse than the standard BMT topology. Clearly, the possibility that some maniraptoran groups are birds needs further testing and should not be dismissed. See Corfe and Butler (2006) for a similar approach to determining whether alternative hypotheses are statistically different from the preferred hypothesis.

A second prediction of the BMT hypothesis is that Aves should be nested within the Maniraptora, as shown in the strict consensus tree of Clark et al. (2002, fig. 2.2). This position is consistent with the generally accepted phylogeny for the Archosauria as a whole (Fig. 2). Our reanalysis of the CNM matrix retrieved *Archaeopteryx* and *Confuciusornis* as associated with maniraptorans,

but interrelationships were ambiguous (Fig. 8). Similarly, our analysis of our matrix showed that birds and maniraptorans are associated; but again, interrelationships are ambiguous (Figs. 9–11). Although they do not establish it, both results are compatible with the possibility that some maniraptorans belong within Aves.

A third prediction of the BMT hypothesis is that a clade of birds and maniraptorans should be nested within the Theropoda, a relationship supported by our reanalysis of the CNM matrix (Fig. 8), where the only taxa used were birds and theropods, but not by the analysis of our matrix, where the relationships among birds and other archosaurs are ambiguous (Figs. 9–11).

A fourth prediction is that, when potential sister groups for birds among early archosaurs are pruned away (and the position of *Longisquama* recovered in other trees is thereby discounted; see Figs. 9 and 12), a clade of birds and maniraptorans will be unambiguously associated with theropods. We found that this clade was only ambiguously associated with theropods in a polytomy with other archosaurs (Figs. 10 and 13).

A fifth prediction is that, when maniraptorans are pruned away, birds should still be clearly associated with more basal theropods, which have been repeatedly identified as having numerous birdlike characters (e.g., Padian 2001b, Paul 2002). Again, however, birds were only ambiguously associated with theropods in a polytomy of higher archosaurs (Figs. 12 and 13). In summary, when statistical tests, bootstrap support, and pruning

are applied to both the standard CNM matrix of Clark et al. (2002) and our more inclusive matrix, major ambiguities are revealed about the strength of support for the BMT hypothesis, and BMT predictions are not supported. Consequently, we conclude that the BMT hypothesis is not only untested but also not more clearly supported than two of the alternatives when evaluated within a comparative phylogenetic framework allowing for its possible refutation.

Are some maniraptorans actually birds more derived than Archaeopteryx?—Our analyses of both the CNM matrix and our new matrix support the possibility that some maniraptorans are birds more derived than *Archaeopteryx*, in the sense of Figures 1B and 3F. This is a major component of three of the alternatives to the BMT hypothesis, including the two supported by our results, the early-archosaur and crocodylomorph hypotheses. Our results suggesting avian status for some maniraptorans indicate that these alternatives should not be rejected at this time. The potential avian status of some maniraptorans should be explored with independent evidence.

With respect to Dromaeosauridae, a strong case has been made for the avian status of *Microraptor*, which has been described as a basal dromaeosaur (Xu et al. 2000, 2003; Hwang et al. 2002). *Microraptor* has multiple characters more derived toward modern birds than those of *Archaeopteryx*, particularly in the pectoral girdle: posterior cervicals with carotid processes, more than five sacrals, ossified uncinete processes, ossified sternal plate (rather than separate plates), costal facets on sternum, sternum with lateral process, anterior margin of sternum grooved anterolaterally for reception of coracoids, scapula/coracoid angle acute, antitrochanter present on ilium, and tibiotarsus present, among others (Xu et al. 2000, 2003; Czerkas et al. 2002; Hwang et al. 2002; Feduccia et al. 2005, 2007; Burnham 2007). Its fore- and hind-limb airfoils are indistinguishable from those of *Archaeopteryx* (Longrich 2006). Burnham (2007) argues that the basal dromaeosaur *Bambiraptor* is also a bird, and Paul (2002) summarizes the character evidence supporting the avian status of all dromaeosaurs. If basal dromaeosaurs belong within Aves, then, given avian monophyly and dromaeosaur monophyly, all dromaeosaurs must belong within Aves (Czerkas et al. 2002; Feduccia 2002; Paul 2002; Feduccia et al. 2005, 2007). If dromaeosaurs are birds, most of which had lost the ability to fly, more-basal dromaeosaurs, like *Microraptor* and

Sinornithosaurus, are expected to be morphologically more similar to flying birds than later, more derived forms, like *Deinonychus* and *Velociraptor* (Paul 2002). This prediction is corroborated by the morphology of these taxa (Paul 2002).

The cladistic analysis of Mayr et al. (2005) supports the placement of dromaeosaurs within Aves; in their cladogram, dromaeosaurs (and troodontids) are the sister group of *Archaeopteryx* and the basal bird *Rahonavis*, and *Confuciusornis* is nested within a clade of troodontids and dromaeosaurs (Mayr et al. 2005, fig. 4). Contrary to Mayr et al. (2005), the simpler interpretation of this topology is that it supports avian status for dromaeosaurs (and troodontids), rather than supporting the authors' interpretation of avian diphyly.

The situation of oviraptorosaurs is less clear. Derived oviraptorosaurs, like *Citipati* and *Ingenia*, possess a number of advanced avian apomorphies: fused prefrontals, reduced maxillae, extensively pneumatized narial region, the shape of the lacrimal ("reverse C-shaped," as in, e.g., *Confuciusornis*; see Martin et al. 1998b), contralateral communication between at least some tympanic diverticulae, fusion of the articular and surangular, articular surface for quadrate with development of either a lateral or a medial process or both, pneumatic presacral vertebrae, more than five sacrals, ossified uncinete processes, ossified sternal plates, costal facets on sternum, sternum with lateral process, and anterior margin of sternum grooved anterolaterally for reception of coracoids, among others (Elzanowski 1999, Maryańska et al. 2002, Paul 2002, Lü et al. 2005). The morphology of basal forms like *Caudipteryx* is more ambiguous and more primitive, but the three characters cited by Ji et al. (1998) and Witmer (2002) in arguing that *Caudipteryx* is not a bird are either incorrect or ambiguous: (1) the quadratojugal is not sutured to the quadrate (Ruben and Jones 2000); (2) whether the quadratojugal and squamosal made contact is unclear; and (3) the presence of an obturator process is not decisive because an obturator process is also present in some Mesozoic birds, such as *Concornis* (Sanz et al. 2002). Some of the characters of *Caudipteryx* cited as purported plesiomorphies by Witmer (2002) and Chiappe and Dyke (2002), such as the nonavian position of the scapula and the nonavian morphology of the coracoid, would be expected if *Caudipteryx* were a flightless bird. The significance of some of the other characters they cite is not clear (e.g., *Caudipteryx* has a deep

mandibular fossa, unlike most Mesozoic birds, but so does *Confuciusornis*). *Caudipteryx* is morphologically no more primitive than *Archaeopteryx* in its tooth morphology, hallucal position, and quadrate morphology; it is more similar morphologically than is *Archaeopteryx* to ornithurines in its possession of a ventral foramen magnum and ossified sternal plates (Feduccia 1999, Paul 2002, Feduccia et al. 2005). Some evidence indicates that other oviraptorosaurs (like *Citipati*) were birds, and a few cladistic analyses have recovered all oviraptorosaurs within Aves (e.g., Lü et al. 2002, Maryańska et al. 2002).

If the preceding arguments are granted, a regress is opened: how many other maniraptoran taxa might belong within Aves? A case for the avian status of Troodontidae could be made on the basis of independent evidence. The morphology of the braincase and otic region of troodontids is fundamentally avian and, in some respects, more derived toward the condition in modern birds than that of *Archaeopteryx* (e.g., hypoglossal [XII] nerve with three or more external foramina in posterolateral region of braincase floor and contralateral communication between at least some tympanic diverticulae, among other characters; see Currie 1985, Currie and Zhao 1993b). Troodontid dentition and patterns of tooth implantation are more like those of birds than like those of nonmaniraptoran theropods (Currie 1987, Norell and Hwang 2004). As noted above, the analysis of Mayr et al. (2005) is compatible with avian status for Troodontidae.

Less clear is whether the Alvarezsauridae represent a flightless radiation within Aves. As noted earlier, their phylogenetic relationships remain contentious, but some studies support their classification as birds more derived than *Archaeopteryx* (e.g., Perle et al. 1993, 1994; Chiappe et al. 1998; Padian 2004), and in our reanalysis of the CNM matrix, constraining alvarezsaurids to be within Aves made no difference in the length of MPTs. The morphology of the bizarre Therizinosauridae is much less like that of birds than is the morphology of oviraptorosaurs, dromaeosaurs, and troodontids.

Our results are compatible with these independent data in suggesting avian status for at least dromaeosaurs and oviraptorosaurs and perhaps for some other currently nonavian maniraptorans. Nevertheless, we appreciate the argument that regarding clades of maniraptorans as flightless and flying radiations within Aves leads

to difficulties. Dramatic restructuring of the skeleton would be required to derive even as birdlike an animal as *Bambiraptor* from something like *Archaeopteryx*. The tail would have to be elongated, the elongate prezygapophyses reacquired, various braincase and otic-region characters lost, and the tooth morphology and the implantation system changed. To derive something like *Deinonychus* or a troodontid would require further changes, but flight loss is known to cause dramatic restructuring of the skeleton in birds, often obscuring phylogenetic relationships (Livezey 1998, 2003; Feduccia 1999, 2002; Paul 2002). The Dromornithidae (Neornithes: Anseriformes) offer a particularly striking example of how morphological restructuring associated with flight loss can obscure even ordinal-level relationships of neornithine taxa (Feduccia 1999, Paul 2002, Murray and Vickers-Rich 2004, and references therein).

If the most birdlike maniraptorans were not flying and flightless radiations within Aves, we must regard their suites of flight-related characters—such as those in the pectoral girdle and the presence of aerodynamic, asymmetrical flight feathers in taxa like *Microraptor*—as exaptations (Paul 2002). Exaptational explanations (Gould and Vrba 1982) for the origins of these characters are common in the literature and are important corollaries of the BMT hypothesis, because they are inferred from the position of maniraptoran and avian taxa on most cladograms (e.g., Padian and Chiappe 1998, Chiappe and Dyke 2002, Xu 2006). Although some or all of the flight-related characters of birds, including those found in the maniraptorans, may have evolved for purposes other than flight, current exaptational explanations offered by BMT proponents are often not fully formulated and rarely offer a biologically plausible hypothesis to account for their origin (Feduccia 1985, 1993, 1995; Paul 2002; Feduccia et al. 2005, 2007). Under such conditions, exaptational explanations should not be regarded as having priority (Rose and Lauder 1996), and adaptational accounts should not be discarded. If the most birdlike maniraptoran clades belong within Aves, problematic exaptational explanations, including those for the origin of flight feathers, are unnecessary.

The potential avian status of the most birdlike maniraptoran taxa should not be dismissed simply because it does not appear in most cladograms. As noted earlier, particularly worrisome

for cladistic evaluation are the characteristic reversals and convergences known to be associated with flight loss (Feduccia 1999, 2002; Paul 2002). As in modern birds, flight loss in Mesozoic birds can involve severe reduction of the forelimb and pectoral girdle, can occur in both aquatic and terrestrial birds, and can involve gigantism. The Hesperornithes (Marsh 1880, Galton and Martin 2002) are the best-known lineage of flightless Mesozoic birds, but at least two other lineages of ornithurines in the Mesozoic were flightless: the hen-sized terrestrial *Patagopteryx* (Chiappe 2002b), which showed reduction of the forelimb and pectoral girdle similar to that in modern flightless birds, and the large but poorly known *Gargantuavis* (Buffetaut and Le Loeuff 1998). Such phenomena all tend to worsen the problems posed by homoplasy in cladistic analyses and make deriving accurate inferences about phylogenetic relationships more difficult (Livezey 1998, 2003). These ordinary problems posed by flight loss would be telescoped, in this case, to the very base of avian evolution (Paul 2002). Mosaic character evolution in early avian history only further complicates the situation (e.g., Zhou 2004, Feduccia 2006). Also, the use of bipedal coelurosaurian outgroups, as in the analysis by Clark et al. (2002), may be contributing to a potentially misleading topology. Outgroup choice determines the polarity of character states, including ancestral reconstructions for entire clades (Nixon and Carpenter 1993). In this case, using bipedal cursors as outgroups may obscure phylogenetic signal by wrongly treating characters indicating flight loss as plesiomorphy.

Weakened support for the BMT hypothesis and the neoflightless-theropod hypothesis.—As noted, because the two alternatives to the BMT hypothesis supported by our results include the avian status of maniraptorans as a significant component, our results and the independent evidence reviewed above support those alternatives. At the very least, our results supporting the avian status of some maniraptorans, which concur with independent evidence, weaken support for the BMT hypothesis. A representative sample of some of the major putative synapomorphies of birds and theropods shows that many are restricted to the Maniraptora (see Table 6, where 21 of 29 characters listed are found only in maniraptorans). If some maniraptorans belong within Aves—and, hence, were removed from consideration in avian ancestry or as potential sister-groups of

Aves—character support for the BMT hypothesis would not be as overwhelming as is now claimed (Feduccia 2002, Feduccia et al. 2005). Although the BMT hypothesis and the modified theropod hypothesis of Paul (2002) would still be potentially supported, these hypotheses would be deprived of their most compelling character support. Despite continuing attempts to reinterpret the morphology of *Archaeopteryx* as that of an earthbound predatory dinosaur (e.g., Paul 2002; Mayr et al. 2005, 2007), comparisons of the morphologies of *Archaeopteryx*, the most basal avian, and non-maniraptoran theropods in general are not favorable (Martin 1985, 1991, 1995; Feduccia 1999, 2002; Feduccia et al. 2005, 2007). Problems with homology statements, character transformations, and corollary issues like the origin of flight would be magnified and simply shifted from birds and maniraptorans onto birds and nonmaniraptoran theropods (Feduccia 2002, Feduccia et al. 2005). The principal characters potentially uniting Aves and nonmaniraptoran theropods are the possible presence of feathers, an advanced mesotarsus, and a functionally tridactyl foot.

Unequivocally vaned feathers are restricted, at present, to the maniraptoran clades Oviraptorosauria and Dromaeosauridae. Fibrous structures in compsognathids (Currie and Chen 2001), tyrannosauroids (Xu et al. 2004), alvarezsaurids (Schweitzer et al. 1999, Schweitzer 2001), therizinosauroids (Xu et al. 1999a), and the dromaeosaur *Sinornithosaurus* (Ji et al. 2001) cannot be unequivocally identified as feathers, despite widespread assertions to the contrary (e.g., Chiappe and Dyke 2002, Norell and Xu 2005). These fibrous structures are indistinguishable from decayed dermal tissue, particularly degraded collagen bundles (Feduccia 2002; Lingham-Soliar 2003a, b; Feduccia et al. 2005; Lingham-Soliar et al. 2007; Lingham-Soliar and Wesley-Smith 2008). Even if these fibrous structures are external integumentary appendages, their homology with avian feathers remains in doubt. Similar structures are preserved in ornithischian dinosaurs and in pterosaurs (Unwin and Bakhurina 1994, Feduccia 2002, Ji and Yuan 2002, Wang et al. 2002, Lingham-Soliar 2003a, Feduccia et al. 2005, Unwin 2006), so these structures may not be homologous with avian feathers (see also Wellnhofer 2004). Ji and Yuan (2002) and Czerkas and Ji (2002) regarded the fibrous integumentary structures of pterosaurs as potentially homologous with avian feathers, implying that feathers are basal to the

TABLE 6. Some of the major potential synapomorphies with birds that support the three major alternative hypotheses for the origin of birds, as suggested by our analysis or postulated in the literature. A “+” indicates that the character is present in at least one taxon, “-” indicates that the character is not present in any taxon, “?” indicates uncertainty as to whether the character is present in any taxa.

	BMT hypothesis ^a	Early-archosaur hypothesis ^b	Crocodylomorph hypothesis ^c
Elongate integumentary structures wider at tips than at bases	+ ^d	+ ^e	-
Vaned integumentary structures	+ ^d	+ ^e	-
Accessory antorbital fenestra(e) in antorbital fossa	+	+	-
Orbits inflated with frontals strongly arched	+ ^d	+	-
Postfrontal absent	+	+	+
Postorbital with ascending process of jugal reduced, descending process of postorbital ventrally elongate	-	+	-
Secondary quadrate articulation with braincase	+ ^d	?	+
Forward migration of quadrate head	+ ^d	?	+
Anterior tympanic recess	+ ^d	?	+
Dorsal tympanic recess	+ ^d	?	+
Posterior tympanic recess opening in columellar recess	+ ^d	?	+
Secondary tympanic membrane opening as fenestra pseudorotunda because of lateral shift of perilymphatic duct	+ ^d	?	+
Elongation of lagena and formation of tubular, elongate cochlear recess	?	?	+ ^f
Vestibule in line with long-axis of cochlear recess	?	?	+ ^f
Basioccipital prominently involved in formation of lower end of cup housing lagena	?	?	+ ^f
Cerebral branches of internal carotid arteries describe sigmoid curves along sides of cranium before meeting in pituitary fossa	-	?	+ ^f
Pneumatic articular	+ ^g	?	+
Teeth lacking serrations, with constrictions between roots and crowns, roots swollen	+ ^d	+ ^h	+
Teeth covered by cementum and attached by periodontal ligament	+ ^d	+ ^h	+
Oval resorption pit perforating tooth lingually and sealed ventrally	+ ^d	+ ^h	+
Loss of interdental plates	+ ^d	+ ^h	+
Bones hollow	+	?	+
Postcranial pneumaticity	+ ^g	?	-
Ossified uncinat processes	+ ^d	-	-
Ossified sterna	+	-	+
Furcula	+ ^g	+	-
Strap-like scapula parallel to vertebral column	+ ^d	+	-
Scapulocoracoid at right angle rather than obtuse	+ ^d	-	-
Elongation of coracoid into a strut-like element	+ ^d	-	+
Coracoid with sternal grooves	+ ^d	-	+
Lateral rotation around distal end of ulna when forelimb is flexed, causing some degree of automatic folding of the manus	+ ^d	?	+
Semilunate distal carpal	+ ^f	-	-
Digits I, II, III prominent; IV and V reduced or lost	+ ^f	-	-
Opisthpubic pelvis	+	?	+ ¹
Exclusion of pubis from acetabulum	-	?	+
Ascending process of astragalus	+	?	-
Advanced mesotarsus	+	?	-
Foot functionally tridactyl	+	?	-

^aBMT = birds are maniraptoran theropod dinosaurs. Sources are primarily Padian and Chiappe (1998), Sereno (1999), Holtz (2000), Norell et al. (2001), Zhou (2004), and Xu (2006).

^bSources are primarily Jones et al. (2000, 2001), Martin (2004), and F. James and J. Pourtless (pers. obs.).

^cSources are primarily Walker (1972, 1977, 1980, 1985, 1990), Whetstone and Martin (1979), Martin et al. (1980), Whetstone and Whybrow (1983), and Martin and Stewart (1999).

^dOnly present in some maniraptoran taxa.

^eCharacter included in our matrix but not coded for *Longisquama*, for conservatism in treatment of contentious homologies.

^fCharacter not included in our matrix because of problems scoring the character for included taxa (see Methods).

^gDistribution uncertain.

^hMartin (2004), L. Martin (pers. comm.), F. James and J. Pourtless (pers. obs.).

¹Only known to be present in *Hallopus*.

clade stemming from the last common ancestor of pterosaurs and birds, but no evidence from the fossil record indicates such a distribution.

Some research on feather development has argued that feathers originated as evolutionarily novel structures not homologous with reptilian scales and that the basal morphology of the feather corresponds to the fibrous structures found in coelurosaurs like *Sinosauropteryx* (Prum 1999, Prum and Brush 2002, Chuong et al. 2003, Prum and Dyck 2003). If true, this proposal would offer support to the identification of such structures as feathers. However, other developmental and molecular work supports the homology of feathers and reptilian scales and does not support the homology of feathers and coelurosaur fibrous structures (e.g., Maderson and Alibardi 2000, Feduccia 2002, Sawyer and Knapp 2003, Sawyer et al. 2003a). Moreover, fossil evidence has revealed the presence of elongate tail feathers in several taxa of Mesozoic birds (e.g., *Protopteryx*, *Paraptopteryx*) that have been interpreted as scale-like, again supporting the homology of feathers and reptilian scales (Zhang and Zhou 2000, Zheng et al. 2007). Similar feathers are also present in the enigmatic *Epidexipteryx* (Zhang et al. 2008), the sister taxon to *Scansoriopteryx*, which is probably not a theropod (Czerkas and Yuan 2002). Sawyer et al. (2003b:27) observed that in turkeys (*Meleagris*), beard bristles, which are structurally similar to the fibrous structures identified as feathers in coelurosaurs, display “simple branching, are hollow, distally, and express the feather-type β keratins,” even though they are not feathers. Sawyer et al. (2003b:30) argued that

the present study raises the possibility that [the] “filamentous integumentary appendages” [of coelurosaurs] may more closely resemble the bristles of the wild turkey beard, and may not depict intermediate stages in the evolution of feathers

and concluded that

Without more detailed information about the cellular and molecular nature of the “filamentous integumentary appendages” of non-avian dinosaurs, and more information on the presence or absence of follicles, it may be premature to assume the homology of all these “filamentous integumentary appendages” with feathers.

Therefore, even if the fibrous structures of coelurosaurs are external integumentary appendages that are structurally and chemically similar to

avian feathers, they may nevertheless not be homologous with modern avian feathers (see also Sawyer and Knapp 2003). In light of these data, tests suggesting that fibrous structures preserved with the alvarezsaurid *Shuvuuia*, structurally similar to those found in other coelurosaurs, show β keratin-specific immunological reactivity and are, therefore, homologous with modern avian feathers (Schweitzer et al. 1999, Schweitzer 2001, Paul 2002), should be interpreted cautiously.

An advanced mesotarsus and functionally tridactyl foot are compelling potential synapomorphies with which to unite birds and non-maniraptoran theropods. Nevertheless, repeated trends toward bipedalism in Archosauria have long been recognized (e.g., by Romer 1956), all involving similar morphological alterations associated with the biophysical constraints of bipedal locomotion (e.g., Tarsitano 1991). Bipedalism is known to induce similar changes in unrelated organisms (e.g., Romer 1956, Coombs 1978, Tarsitano 1991, Berman et al. 2000). Trends toward bipedalism are apparent even in nonarchosaurian diapsids; the pelvis and hind limb of the Permian bolosaurid *Eudibamus* are modified for cursorial bipedal locomotion and parasagittal digitigrade posture, as in theropods (Berman et al. 2000). Similar trends toward bipedalism are evident in the basal archosaur *Euparkeria* (Ewer 1965), in more derived crurotarsal taxa like *Postosuchus* and *Ornithosuchus* (Walker 1964, Chatterjee 1985, Feduccia 1999), and in the “sphenosuchian” crocodylomorphs (Colbert 1952; Walker 1972, 1990; Crush 1984). In all cases where crurotarsal archosaurs developed bipedalism, their skeletal anatomy, particularly in the pelvic girdle and hind limb, closely converged upon the anatomy of avemetatarsalian archosaurs, especially theropods (Romer 1956, Walker 1964, Chatterjee 1985, Feduccia 1999, Nesbitt 2007, and references therein). In the case of *Effigia*, the trend toward bipedalism produced extreme convergence throughout the cranial and postcranial skeleton on that of highly cursorial ornithomimosaur, with further convergence on numerous characters of the avemetatarsalian, dinosaurian, theropod, neotetanurine, and coelurosaurian skeletons; in some cases, the relevant characters are identical across taxa (Nesbitt and Norell 2006, Nesbitt 2007). Nesbitt et al. (2007:71) concluded that the “many convergences between *Effigia* and ornithomimids suggest that a ‘theropod-like body plan’ developed in a group of crocodile-line archosaurs before it evolved in

later theropod dinosaurs." Clearly, the convergence upon dinosaurian and avemetatarsalian anatomy seen in numerous lineages of crurotarsal archosaurs is more than superficial. Although none of these taxa possesses an advanced mesotarsus, a simple mesotarsus is present in *Euparkeria*. Walker (1972, 1977) outlined a plausible functional scenario whereby an advanced mesotarsus could be derived from a crurotarsal joint as trends toward bipedalism continued (see also Romer 1956). Moreover, in facultatively bipedal crurotarsal taxa, the outer metatarsals decrease in length and the metatarsus becomes more elongate and compact, approximating the condition in theropods, although in none of these taxa is the foot functionally tridactyl (e.g., Colbert 1952, Crush 1984, Walker 1990). As noted by Walker (1977), Martin (1983, 2004), and Feduccia (1999), the biophysical pressures operating on an arboreal organism leaping between trees are similar to those operating on a terrestrial biped, which suggests that the advanced mesotarsus and functionally tridactyl foot of birds may have arisen by a different functional trajectory from that of non-maniraptoran theropods.

These three characters (the possible presence of feathers, an advanced mesotarsus, and a functionally tridactyl foot) do not unambiguously support the alignment of Aves (inclusive of some maniraptorans) and nonmaniraptoran theropods to the exclusion of other archosaurian taxa. Given these data, and our results supporting alternatives to the BMT and neoflightless-theropod hypotheses, Theropoda as presently constituted may not be monophyletic. Aves, including at least some maniraptorans, may be more closely related to some other archosaurian taxon. The claim that some maniraptorans may be birds and not theropods is not contradictory. If some maniraptorans belong within Aves, their phylogenetic relationships with theropods are contingent upon whether Aves belongs within Theropoda, and, as noted, comparisons of birds and those theropods that remain when Maniraptora are reclassified as birds are not favorable. Note that, although Theropoda is widely accepted as a well-supported clade, the analysis of Benton (2004) demonstrated that the only unequivocal synapomorphy diagnosing Theropoda is the presence of an intramandibular joint. An intramandibular joint is also present in crurotarsal taxa like *Postosuchus* (Chatterjee 1985) and *Ornithosuchus* (Walker 1964), is not primitively present in birds, and is erratically

distributed among maniraptorans. Clearly, then, this character does not strongly support monophyly of Theropoda as presently constituted. Interestingly, analysis of our matrix supported the possibility of monophyly of a weakly supported clade of theropods excluding maniraptorans (Figs. 9–10). If some maniraptorans were birds, and if birds were not theropods, similarities between maniraptorans and theropods could be readily explained by convergence on a cursorial morphotype subsequent to the loss of flight. Even distantly related reptiles could converge closely, in some cases almost indistinguishably, on the theropod morphotype through the acquisition of cursoriality, as the case of *Effigia*, noted above, dramatically demonstrates (Nesbitt and Norell 2006, Nesbitt 2007). If this is the case, some maniraptorans represent lineages of cryptic birds whose true phylogenetic relationships have been obscured by convergence and the loss of flight. Given the evidence that some maniraptorans may belong within Aves and that, consequently, Aves may not belong within Theropoda, this possibility must be seriously considered.

Note that (1) if the core maniraptorans, at least, are not dinosaurs but rather a cryptic lineage of birds, and (2) if Aves does not belong within Theropoda, as is likely if core maniraptorans are in fact birds and (3) if the inference of a manual digital identity of II, III, and IV in modern birds is correct (e.g., Burke and Feduccia 1997, Feduccia and Nowicki 2002, Kundrát et al. 2002), then the manus of core maniraptorans is probably composed of digits II, III, and IV. If this inference is correct, determination of carpal and manual homologies between birds and maniraptorans would be simplified (see Appendix 3), but neither the homology of manual digits of core maniraptorans and birds nor the homology of manual digits of theropods in general and birds can be determined at present, and to assume that they are homologous is unwarranted.

Are alternatives to the BMT hypothesis compatible with the evidence?—Analysis of our new matrix indicated that both the early-archosaur and crocodylomorph hypotheses are at least as strongly supported as the BMT. In addition to the support for these hypotheses derivable from our trees, we found, using Kishino-Hasegawa tests, that the topologies of the crocodylomorph and early-archosaur hypotheses were at least as likely as the standard BMT hypothesis (the hypothesis of no difference could not be rejected). *P* values for the

other hypotheses were smaller, which suggests larger differences (Table 3). The hypothesis that birds evolved twice and Paul's hypothesis that some maniraptorans belong within Aves but that Aves still belongs within the Theropoda also appeared to be less likely in terms of the number of steps in their MPTs. The alternative hypothesis of Kurochkin (2006a, b), postulating avian diphyly, is least supported. Also unclear is what characters could unite the derived ornithurines (which are already morphologically advanced when they appear in the fossil record; e.g., Feduccia 1999) with an unspecified archosauromorph lineage.

In addition to the results obtained through use of Kishino-Hasegawa tests, we also recovered a clade of maniraptorans, birds, and the basal archosaur *Longisquama*, though we note that it was only weakly supported (Figs. 9 and 12). These results nevertheless support the possibility of a sister-group relationship between *Longisquama* and Aves (inclusive of some maniraptorans). In addition, birds and maniraptorans were never unambiguously associated with nonmaniraptoran theropods in any of our trees (Figs. 9–13). A variant of the crocodylomorph hypothesis may also be correct, because the polytomies recovered in Figures 10 and 13 do not preclude at least a sister-group relationship between birds and crocodylomorphs, agreeing with our Kishino-Hasegawa tests.

Our results with respect to the early-archosaur hypothesis concur with some independent evidence. Diagnosable potential synapomorphies exist with which to unite *Longisquama* and Aves (inclusive of some maniraptorans; Table 6). To be conservative, we did not score the integumentary structures associated with the type skeleton of *Longisquama* as structurally homologous with avian feathers. The data provided by Jones et al. (2000 [figs. 2–6], 2001) and Martin (2004) support the interpretation of the integumentary structures as homologous with avian feathers, but Prum (2001), Unwin and Benton (2001), and Paul (2002), among others, have disagreed. Voigt et al. (2009) did not consider the integumentary structures of *Longisquama* to be homologous with either avian feathers or reptilian scales. Nevertheless, they concluded that the integument of *Longisquama* shares several morphological characters with feathers and developed through a two-stage process similar to that by which feathers develop. Interestingly, the long scale-like feathers of *Protopteryx* (Zhang and Zhou 2000)

and *Paraprotopteryx* (Zheng et al. 2007) are somewhat similar, at least in overall appearance, to the integumentary structures of *Longisquama*. Our recovery of *Longisquama* in a weakly supported clade with birds and maniraptorans (Figs. 9 and 12) lends some support to the interpretation of Jones et al. (2000, 2001) and Martin (2004).

Unfortunately, a detailed osteology of *Longisquama* has not been published. Martin (2004) has identified potential synapomorphies shared by the cranial and pectoral skeletons of *Longisquama* and birds that have previously been overlooked, including a subdivided antorbital fenestra (Martin 2004, fig. 4; Fig. 15), which other authors have regarded as an important synapomorphy of birds and theropods (e.g., Paul 2002). Examination of the skull of *Longisquama* as preserved on the counterslab of the main specimen supports Martin's interpretation (Fig. 15). A preorbital vacuity delimited by the lacrimal posteriorly, the maxilla ventrally, and the nasal dorsally is a large antorbital fenestra; the rostral portion of the skull beyond the antorbital fossa is not preserved (the slab is broken just beyond the antorbital fossa). The size and location of this vacuity, extending from the rostral portion of the skull posteriorly to the anterior border of the lacrimal, is inconsistent with identification as the naris. It can only be the antorbital fenestra. The ventral swelling of the nasal and the dorsal swelling of the maxilla are similar to the processes observed in other archosaur taxa with subdivided antorbital fenestrae and support the inference that an accessory antorbital fenestra was present. In fact, the lower half of the strut of bone arising from these processes and delimiting the posterior edge of the accessory antorbital fenestra is visible above the dorsal swelling of the maxilla. The orbit is considerably inflated, causing moderate vaulting of the frontals. The posterior skull is enlarged, and the parietals are bulged, which suggests expansion of the brain. Senter (2004) argued that the parietals were ornamented with ridges or bumps, but these appear to be a preservation defect of the posterior skull (F. James and J. Pourtless pers. obs.). The temporal fenestrae appear to be confluent with the orbit, as in birds; alternatively, the upper temporal fenestra may be preserved (question mark in Fig 15; but this feature is probably a preservation defect). The long postorbital was dislodged postmortem and now intrudes into the orbit; its base is anterior to the small ascending process of the jugal. Consequently, the orbit would have been rounder in

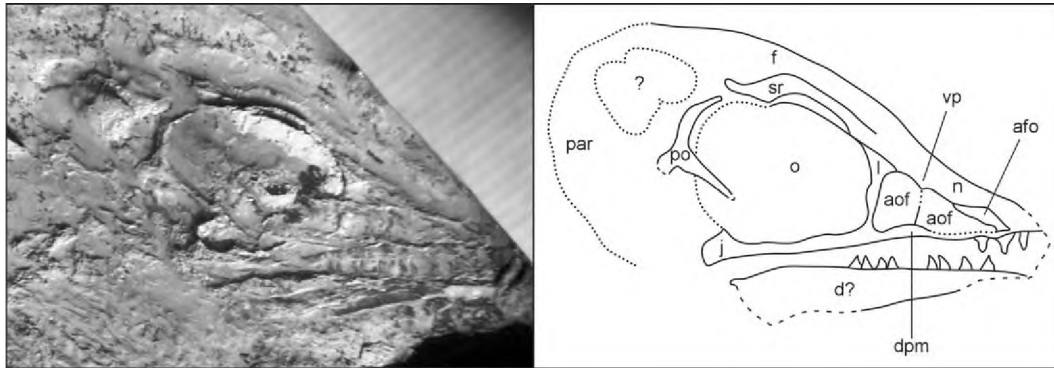

FIG. 15. Skull of *Longisquama insignis* as preserved on the counterslab of the type specimen (left) and a reconstruction and interpretation of the cranial osteology (right). Note the birdlike overall appearance and construction of some of the cranial elements. See text (Discussion section) for details. Abbreviations: af = antorbital fossa, aof = antorbital fenestra, d? = dentary and other mandibular elements, dpm = dorsal process of maxilla supporting the strut of bone subdividing the antorbital fenestra and delimiting an accessory antorbital fenestra, f = frontal, j = jugal, l = lacrimal, n = nasal, o = orbit, par = paroccipital, po = postorbital, sr = supraorbital ridge of the frontal, vp = ventral process of the nasal supporting the strut of bone subdividing the antorbital fenestra and delimiting an accessory antorbital fenestra, and ? = a preservation defect or, less probably, the upper temporal fenestra. Dashes indicate breaks in the bone or in the matrix. Dotted lines indicate inferred or partially preserved structures or uncertain borders of cranial elements. Photograph by John Ruben, provided by courtesy of Larry Martin.

life. Interestingly, *Longisquama* has the same dental morphology style as birds and crocodyliform crocodylomorphs (Martin 2004, L. Martin pers. comm., F. James and J. Pourtless pers. obs.; Fig. 15). The dentary and mandibular elements are not well preserved on the counterslab. The appendicular skeleton is generalized, but a furcula is present, and the scapula is straplike (Sharov 1970; Jones et al. 2000 [fig. 1], 2001). Unfortunately, the pelvic girdle and hind limb of *Longisquama* are not known, so further comparisons with birds are not currently possible. The subdivision of the antorbital fenestra, the expansion of the orbit, the morphology of the postorbital, the expansion of the posterior skull suggesting expansion of the brain, the thin jugal with small ascending process, the dental morphology, and the presence of a furcula provide osteological support for an association of *Longisquama* with birds independently of the integumentary structures. We do not assert that *Longisquama* is the sister taxon of Aves (inclusive of some maniraptorans), but such a relationship is one possibility that is supported by our results and by some character evidence.

Some independent evidence also supports our results with respect to the crocodylomorph hypothesis. Several diagnosable potential synapomorphies could unite crocodylomorph taxa and

Aves (inclusive of some maniraptorans; Table 6), either as sister taxa, as proposed by Walker (1972), or perhaps according to the topologies proposed by Martin et al. (1980), Whetstone and Whybrow (1983), and Martin and Stewart (1999). The structures of the skull, and in particular of the braincases and otic regions of crocodylomorphs and birds, show numerous detailed similarities, including extensive pneumaticity associated with the ear (Walker 1972 [figs. 1, 5, 6], 1990 [e.g., figs. 15–30, 48, 51, 52]; Whetstone and Martin 1979). The dentitions and dental systems of crocodyliform crocodylomorphs and toothed birds are nearly indistinguishable (Martin et al. 1980 [fig. 2]; Martin 1985 [fig. 1], 1991 [figs. 15–18]; Martin and Stewart 1999 [figs. 1–3]). Some evidence also implies that some crocodylomorphs, like the “sphenosuchians” (on paraphyly of “Sphenosuchia,” see Clark and Sues 2002, Sues et al. 2003), were descended from arboreal ancestors (Walker 1972). An arboreal origin of flight could therefore be compatible with a crocodylomorph hypothesis for the origin of birds (Walker 1972). Some crocodylomorphs had long, ossified sterna (Crush 1984, fig. 7B). The coracoids of “sphenosuchians” and birds are not dissimilar, and the latter could easily be derived from the former (Walker 1972, fig. 7). During flexion of the humerus in

crocodylomorphs, mechanical linkage of elements causes the manus and carpus to rotate laterally around the distal end of the ulna, which is similar to avian wing folding (Walker 1972, fig. 8). At least one crocodylomorph, *Hallopus*, may even have had an opisthopic pelvis (Walker 1970, 1972 [fig. 9]). Some characters regularly offered as indicating a close relationship between birds and theropods, such as a light skeleton with hollow bones, are also found in "sphenosuchian" crocodylomorphs (Colbert 1952; Walker 1972, 1990; Crush 1984; Table 6). An obvious problem with this hypothesis is the conversion of the crurotarsal ankle to a mesotarsal ankle, but, as noted earlier, Walker's (1972, 1977) solution to this problem merits further attention. Again, we do not assert that a variant of the crocodylomorph hypothesis is correct, but this is another possibility that is supported by our results and by some character evidence.

Despite the support our analysis offers to these two alternatives to the BMT hypothesis, and in spite of the failure of our analyses to support predictions derivable from the BMT, we reiterate that our analyses do not permit a single hypothesis for the origin of birds to be singled out as correct at this time. Our results neither conclusively refute the BMT hypothesis nor conclusively support either of the two alternatives discussed above. However, our analysis indicates (1) that, of the five current hypotheses for the origin of birds, the BMT hypothesis, the early-archosaur hypothesis, and a variant of the crocodylomorph hypothesis are most compatible with presently available data; and (2) that the BMT hypothesis is not clearly preferable to these two alternatives. Discrimination among these three hypotheses may be aided by derivation of predictions from each and performance of tests that establish whether these predictions are supported, but, at present, ambiguities in the data complicate discrimination among the three. Insufficient information from the fossil record (e.g., Heckert and Lucas 2003) and uncertainties about the homologies of key characters in archosaur evolution contribute to this difficulty (see Appendix 3). The potential synapomorphies that may underlie any of these three topologies also overlap considerably (Table 6). These data and our results, consistently retrieving a polytomy of archosaurs more derived than basal-most forms like *Euparkeria* and *Erythrosuchus* (Figs. 9–13), support the earlier consensus, partially challenged by Gower and

Wilkinson (1996), that phylogenetic relationships among Archosauria are poorly understood (e.g., Romer 1956, Charig 1993, Feduccia 1999). Clearly, extensive homoplasy is at work. In such cases, even rigorous applications of cladistic methods can fail to resolve phylogenetic relationships accurately (e.g., Gosliner and Ghiselin 1984, Carroll 1988, Carroll and Dong 1991, Wiens et al. 2003). The present uncertainties in discriminating among the BMT, early-archosaur, and crocodylomorph hypotheses are an invitation to further study. The neoflightless-theropod hypothesis of Paul, or even the "birds-evolved-twice" hypothesis of Kurochkin, may prove correct in the light of future discoveries. Such uncertainty drives the growth of scientific knowledge, and it should be welcomed rather than discounted.

CONCLUSIONS

We have pursued two goals: evaluation of whether the BMT hypothesis is as well supported as has been claimed, and evaluation of alternative hypotheses for the origin of birds within a comparative phylogenetic framework. We conclude that, because of circularity in the construction of matrices, inadequate taxon sampling, insufficiently rigorous application of cladistic methods, and a verificationist approach, the BMT hypothesis has not been subjected to sufficiently rigorous attempts at refutation, and the literature does not provide the claimed overwhelming support. Our analyses and independent data indicate that two of the alternatives to the BMT hypothesis are as probable as the BMT and are potentially supported by specific osteological data. These alternatives are the early-archosaur hypothesis, positing a sister-group relationship between *Longisquama* and Aves, and a variant of the crocodylomorph hypothesis. Both hypotheses include the proposition that some maniraptorans are actually birds more derived than *Archaeopteryx*.

Ostrom (1975, 1976a, b) and subsequent researchers like Gauthier (1986) were correct in noting the extensive similarities between maniraptorans and birds, a conclusion only strengthened by more recent discoveries, but evidence suggests that at least some maniraptorans belong within Aves. If Aves (inclusive of some maniraptorans) does not belong within Theropoda, at least some maniraptorans should be classified as birds rather than dinosaurs, and Aves should not be considered a lineage of living

dinosaurs. On the basis of our results, the next two major challenges are to evaluate further the possibility that some maniraptorans in fact belong within Aves, rather than the reverse, and to further explore whether birds may have been derived from theropods, "early archosaurs," or crocodylomorphs, the three most likely candidates given current evidence. At present, the origin of birds is an open question.

ACKNOWLEDGMENTS

We are especially grateful to M. Holder, who guided us through the construction of our matrix and our entire analysis and spent many hours discussing systematics with us. For general advice and comments on earlier drafts of the manuscript, we thank P. Beerli, D. Burnham, F. Crews, P. Currie, G. Dyke, A. Feduccia, A. James, H. James, P. Kareiva, E. Kurochkin, L. Martin, G. Mayr, C. McCulloch, G. Naylor, S. Olson, G. Paul, D. Steadman, S. Steppan, D. Swofford, K. van der Linde, J. Wilgenbusch, and R. Zusi. For help with the literature and access to collections we thank G. Erickson (Florida State University), L. Martin (University of Kansas), and P. Currie and J. Gardner (Royal Tyrell Museum). We thank K. Womble and S. Bonner for constructing our figures. For outstanding editorial assistance, we thank A. B. Thistle. For Russian translations, we thank M. Ustyenko and D. Jeltovski. For information on the Theropod Working Group, see research.amnh.org/users/norell/TWGhome.html.

LITERATURE CITED

- BARSBOLD, R., P. J. CURRIE, N. P. MYHRVOLD, H. OSMÓLSKA, K. TSOGTBAAATAR, AND M. WATABE. 2000. A pygostyle from a non-avian theropod. *Nature* 403:155–156.
- BARSBOLD, R., AND T. MARYAŃSKA. 1990. Segnosauria. Pages 408–415 in *The Dinosauria* (D. B. Weishampel, P. Dodson, and H. Osmólska, Eds.). University of California Press, Berkeley.
- BARSBOLD, R., AND H. OSMÓLSKA. 1990. Ornithomimosauria. Pages 225–244 in *The Dinosauria* (D. B. Weishampel, P. Dodson, and H. Osmólska, Eds.). University of California Press, Berkeley.
- BARSBOLD, R., AND H. OSMÓLSKA. 1999. The skull of *Velociraptor* (Theropoda) from the Late Cretaceous of Mongolia. *Acta Palaeontologica Polonica* 44:189–219.
- BARSBOLD, R., AND A. PERLE. 1984. On the first new find of a primitive ornithomimosaur from the Cretaceous of the M.P.R. [In Russian.] *Paleontological Journal* 1984:121–123.
- BAUMEL, J. J., AND L. J. WITMER. 1993. Osteologia. Pages 45–132 in *Handbook of Avian Anatomy: Nomina Anatomica Avium*, 2nd ed. (J. J. Baumel, A. S. King, J. E. Breazile, H. E. Evans, and J. C. Vanden Berge, Eds.). Nuttall Ornithological Club, Cambridge, Massachusetts.
- BEEBE, C. W. 1915. A tetrapteryx stage in the ancestry of birds. *Zoologica* 2:38–52.
- BELLAIRS, A. D'A., AND C. R. JENKIN. 1960. The skeleton of birds. Pages 241–300 in *Biology and Comparative Physiology of Birds*, vol. 1 (A. J. Marshall, Ed.). Academic Press, New York.
- BENNETT, S. C. 2008. Ontogeny and *Archaeopteryx*. *Journal of Vertebrate Paleontology* 28:535–542.
- BENTON, M. J. 1999. *Scleromochlus taylori* and the origin of dinosaurs and pterosaurs. *Philosophical Transactions of the Royal Society of London, Series B* 354:1423–1446.
- BENTON, M. J. 2004. Origin and relationships of Dinosauria. Pages 7–19 in *The Dinosauria*, 2nd ed. (D. B. Weishampel, P. Dodson, and H. Osmólska, Eds.). University of California Press, Berkeley.
- BENTON, M. J., AND A. D. WALKER. 2002. *Erpetosuchus*, a crocodile-like basal archosaur from the Late Triassic of Elgin, Scotland. *Zoological Journal of the Linnean Society* 136:25–47.
- BERMAN, D. S., R. R. REISZ, D. SCOTT, A. C. HENRICI, S. S. SUMIDA, AND T. MARTENS. 2000. Early Permian bipedal reptile. *Science* 290:969–972.
- BROCHU, C. A. 2003. Osteology of *Tyrannosaurus rex*: Insights from a Nearly Complete Skeleton and High-resolution Computed Tomographic Analysis of the Skull. *Society of Vertebrate Paleontology Memoirs*, no. 7.
- BROOM, R. 1913. On the South African pseudosuchian *Euparkeria* and allied genera. *Proceedings of the Zoological Society of London* 1913:619–633.
- BRYANT, H. N., AND A. P. RUSSELL. 1993. The occurrence of clavicles within Dinosauria: Implications for the homology of the avian furcula and the utility of negative evidence. *Journal of Vertebrate Paleontology* 13:171–184.
- BUFFETAUT, E., AND J. LE LOEUFF. 1998. A new giant ground bird from the Upper Cretaceous of southern France. *Journal of the Geological Society of London* 155:1–4.
- BURGERS, P., AND L. M. CHIAPPE. 1999. The wing of *Archaeopteryx* as a primary thrust generator. *Nature* 399:60–62.
- BURGERS, P., AND K. PADIAN. 2001. Why thrust and ground effect are more important than lift in the evolution of sustained flight. Pages 351–361 in *New Perspectives on the Origin and Early Evolution of Birds: Proceedings of the International Symposium in Honor of John H. Ostrom* (J. Gauthier and L. F. Gall, Eds.). Yale University Press, New Haven, Connecticut.
- BURKE, A. C., AND A. FEDUCCIA. 1997. Developmental patterns and the identification of homologies in the avian hand. *Science* 278:666–669.

- BURNHAM, D. A. 2004. New information on *Bambiraptor feinbergi* (Theropoda: Dromaeosauridae) from the Late Cretaceous of Montana. Pages 67–111 in *Feathered Dragons: Studies on the Transition from Dinosaurs to Birds* (P. J. Currie, E. B. Koppelhus, M. A. Shugar, and J. L. Wright, Eds.). Indiana University Press, Bloomington.
- BURNHAM, D. A. 2007. Paleoenvironment, paleoecology, and evolution of maniraptoran “dinosaurs.” Ph.D. dissertation, University of Kansas, Lawrence.
- BURNHAM, D. A., K. L. DERSTLER, P. J. CURRIE, R. T. BAKER, Z. ZHOU, AND J. H. OSTROM. 2000. Remarkable new birdlike dinosaur (Theropoda: Maniraptora) from the Upper Cretaceous of Montana. *University of Kansas Paleontological Contributions* 13:1–14.
- CARPENTER, K., C. MILES, J. H. OSTROM, AND K. CLOWARD. 2005. Redescription of the small maniraptoran theropods *Ornitholestes* and *Coelurus* from the Upper Jurassic Morrison Formation of Wyoming. Pages 49–71 in *The Carnivorous Dinosaurs* (K. Carpenter, Ed.). Indiana University Press, Bloomington.
- CARROLL, R. L. 1988. *Vertebrate paleontology and evolution*. W. H. Freeman, New York.
- CARROLL, R. L., AND Z. M. DONG. 1991. *Hupehsuchus*, an enigmatic aquatic reptile from the Triassic of China, and the problem of establishing relationships. *Philosophical Transactions of the Royal Society of London, Series B* 331:131–153.
- CHARIG, A. J. 1993. Recently proposed phylogenetic analyses of the Triassic Archosauria: A critical comparison and evaluation, facilitated by a simple technique for the modification of conflicting dendrograms. *Paleontologia Lombarda della Societa Italiana di Scienze Naturali e del Museo Civico di Storia Natrale di Milano, Nuova Serie* 2:45–62.
- CHATTERJEE, S. 1985. *Postosuchus*, a new thecodontian reptile from the Triassic of Texas and the origin of tyrannosaurs. *Philosophical Transactions of the Royal Society of London, Series B* 309:395–460.
- CHATTERJEE, S. 1991. Cranial anatomy and relationships of a new Triassic bird from Texas. *Philosophical Transactions of the Royal Society of London, Series B* 332:277–346.
- CHATTERJEE, S. 1997. *The Rise of Birds: 225 Million Years of Evolution*. Johns Hopkins University Press, Baltimore, Maryland.
- CHATTERJEE, S., AND R. J. TEMPLIN. 2004. Feathered coelurosaurs from China: New light on the arboreal origin of avian flight. Pages 251–281 in *Feathered Dragons: Studies on the Transition from Dinosaurs to Birds* (P. J. Currie, E. B. Koppelhus, M. A. Shugar, and J. L. Wright, Eds.). Indiana University Press, Bloomington.
- CHIAPPE, L. M. 1992. Enantiornithine (*Aves*) tarsometatarsi and the avian affinity of the Late Cretaceous Avisauridae. *Journal of Vertebrate Paleontology* 12:344–350.
- CHIAPPE, L. M. 2002a. Basal bird phylogeny: Problems and solutions. Pages 448–472 in *Mesozoic Birds: Above the Heads of Dinosaurs* (L. M. Chiappe and L. M. Witmer, Eds.). University of California Press, Berkeley.
- CHIAPPE, L. M. 2002b. Osteology of the flightless *Patagopteryx deferrariisi* from the Late Cretaceous of Patagonia (Argentina). Pages 281–316 in *Mesozoic Birds: Above the Heads of Dinosaurs* (L. M. Chiappe and L. M. Witmer, Eds.). University of California Press, Berkeley.
- CHIAPPE, L. M. 2007. *Glorified Dinosaurs: The Origin and Early Evolution of Birds*. Wiley, Hoboken, New Jersey.
- CHIAPPE, L. M., AND G. J. DYKE. 2002. The Mesozoic radiation of birds. *Annual Review of Ecology and Systematics* 33:91–124.
- CHIAPPE, L. M., S. JI, Q. JI, AND M. A. NORELL. 1999. Anatomy and systematics of the Confuciusornithidae (Theropoda: Aves) from the late Mesozoic of northeastern China. *Bulletin of the American Museum of Natural History* 242:1–89.
- CHIAPPE, L. M., M. A. NORELL, AND J. M. CLARK. 1998. The skull of a relative of the stem-group bird *Mononykus*. *Nature* 392:275–278.
- CHIAPPE, L. M., M. A. NORELL, AND J. M. CLARK. 2002. The Cretaceous, short-armed Alvarezsauridae: *Mononykus* and its kin. Pages 87–120 in *Mesozoic Birds: Above the Heads of Dinosaurs* (L. M. Chiappe and L. M. Witmer, Eds.). University of California Press, Berkeley.
- CHIAPPE, L. M., AND C. WALKER. 2002. Skeletal morphology and systematics of the Cretaceous Euenantiornithines (Ornithothoraces: Enantiornithes). Pages 240–267 in *Mesozoic Birds: Above the Heads of Dinosaurs* (L. M. Chiappe and L. M. Witmer, Eds.). University of California Press, Berkeley.
- CHIAPPE, L. M., AND L. M. WITMER, Eds. 2002. *Mesozoic Birds: Above the Heads of Dinosaurs*. University of California Press, Berkeley.
- CHRISTIANSEN, P. 2006. Allometry in phylogeny and *Archaeopteryx*. *Journal of Vertebrate Paleontology* 26:480–486.
- CHUONG, C. M., P. WU, F. ZHANG, X. XU, M. YU, R. B. WIDELITZ, T. JIANG, AND L. HOU. 2003. Adaptation to the sky: Defining the feather with integument fossils from Mesozoic China and experimental evidence from molecular laboratories. *Journal of Experimental Zoology B* 298:42–56.
- CHURE, D. J. 2001. The wrist of *Allosaurus* (Saurischia: Theropoda), with observations on the carpus in theropods. Pages 283–300 in *New Perspectives on the Origin and Early Evolution of Birds: Proceedings of the International Symposium in Honor of John H. Ostrom* (J. Gauthier and L. F. Gall, Eds.). Yale University Press, New Haven, Connecticut.
- CHURE, D. J., AND J. H. MADSEN, JR. 1996. On the presence of furculae in some non-maniraptoran theropods. *Journal of Vertebrate Paleontology* 18:573–577.

- CLARK, J. M., T. MARYAŃSKA, AND R. BARSBOLD. 2004. Therizinosauroida. Pages 151–164 *in* The Dinosauria, 2nd ed. (D. B. Weishampel, P. Dodson, and H. Osmólska, Eds.). University of California Press, Berkeley.
- CLARK, J. M., M. A. NORELL, AND R. BARSBOLD. 2001. Two new oviraptorids (Theropoda: Oviraptorosauria) Late Cretaceous Djadoktha Formation, Ukhaa Tolgod, Mongolia. *Journal of Vertebrate Paleontology* 21:209–213.
- CLARK, J. M., M. A. NORELL, AND L. M. CHIAPPE. 1999. An oviraptorid skeleton from the Late Cretaceous of Ukhaa Tolgod, Mongolia, preserved in an avian-like brooding position over an oviraptorid nest. *American Museum Novitates* 3265:1–36.
- CLARK, J. M., M. A. NORELL, AND P. J. MAKOVICKY. 2002. Cladistic approaches to the relationships of birds to other theropod dinosaurs. Pages 31–60 *in* Mesozoic Birds: Above the Heads of Dinosaurs (L. M. Chiappe and L. M. Witmer, Eds.). University of California Press, Berkeley.
- CLARK, J. M., A. PERLE, AND M. NORELL. 1994. The skull of *Erylosaurus andrewsi*, a Late Cretaceous “segnosaur” (Theropoda: Therizinosauroida) from Mongolia. *American Museum Novitates* 3115:1–39.
- CLARK, J. M., AND H.-D. SUES. 2002. Two new basal crocodylomorph archosaurs from the Lower Jurassic and the monophyly of the Sphenosuchia. *Zoological Journal of the Linnean Society* 136:77–95.
- CLARK, J. M., H.-D. SUES, AND D. S. BERMAN. 2000. A new specimen of *Hesperosuchus agilis* from the Upper Triassic of New Mexico and the interrelationships of basal crocodylomorph archosaurs. *Journal of Vertebrate Paleontology* 20:683–704.
- CLARK, J. M., J. WELMAN, J. A. GAUTHIER, AND J. M. PARRISH. 1993. The laterosphenoid bone of early archosauriforms. *Journal of Vertebrate Paleontology* 13:48–57.
- CLARKE, J. A. 2004. Morphology, phylogenetic taxonomy, and systematics of *Ichthyornis* and *Apatornis* (Avialae: Ornithurae). *Bulletin of the American Museum of Natural History* 286:1–179.
- CLARKE, J. A., AND M. A. NORELL. 2002. The morphology and phylogenetic position of *Apsaravis ukhaana* from the Late Cretaceous of Mongolia. *American Museum Novitates* 3387:1–46.
- COLBERT, E. H. 1952. A pseudosuchian reptile from Arizona. *Bulletin of the American Museum of Natural History* 99:565–592.
- COLBERT, E. H. 1989. The Triassic dinosaur *Coelophysis*. *Bulletin of the Museum of Northern Arizona* 57:1–160.
- COLBERT, E. H., AND D. A. RUSSELL. 1969. The small Cretaceous dinosaur *Dromaeosaurus*. *American Museum Novitates* 2380:1–49.
- COOMBS, W. P., JR. 1978. Theoretical aspects of cursorial adaptations in dinosaurs. *Quarterly Review of Biology* 53:393–418.
- CORFE, I. J., AND R. J. BUTLER. 2006. Comment on “A well-preserved *Archaeopteryx* specimen with theropod features.” *Science* 313:1238b.
- CRANSTON, K. A., AND B. RANNALA. 2007. Summarizing a posterior distribution of trees using agreement subtrees. *Systematic Biology* 56:578–590.
- CRUICKSHANK, A. R. I. 1972. The proterosuchian thecodonts. Pages 89–119 *in* Studies in Vertebrate Evolution: Essays Presented to F. R. Parrington (K. A. Joysey and T. S. Kemp, Eds.). Oliver and Boyd, Edinburgh, United Kingdom.
- CRUSH, P. J. 1984. A late Upper Triassic sphenosuchid crocodylian from Wales. *Palaeontology* 27:131–157.
- CURRIE, P. J. 1985. Cranial anatomy of *Stenonychosaurus inequalis* (Saurischia, Theropoda) and its bearing on the origin of birds. *Canadian Journal of Earth Science* 22:1643–1658.
- CURRIE, P. J. 1987. Bird-like characteristics of the jaws and teeth of troodontid theropods (Dinosauria, Saurischia). *Journal of Vertebrate Paleontology* 7:72–81.
- CURRIE, P. J. 1995. New information on the anatomy and relationships of *Dromaeosaurus albertensis* (Dinosauria: Theropoda). *Journal of Vertebrate Paleontology* 15:576–591.
- CURRIE, P. J., AND P. CHEN. 2001. Anatomy of *Sinosauropteryx prima* from Liaoning, northeastern China. *Canadian Journal of Earth Sciences* 38:1705–1727.
- CURRIE, P. J., AND Z. DONG. 2001. New information on Cretaceous troodontids (Dinosauria, Theropoda) from the People’s Republic of China. *Canadian Journal of Earth Sciences* 38:1753–1766.
- CURRIE, P. J., E. B. KOPPELHUS, M. A. SHUGAR, AND J. L. WRIGHT, Eds. 2004. Feathered Dragons: Studies on the Transition from Dinosaurs to Birds. Indiana University Press, Bloomington.
- CURRIE, P. J., AND X. ZHAO. 1993a. A new carnosaur (Dinosauria, Theropoda) from the Jurassic of Xinjiang, People’s Republic of China. *Canadian Journal of Earth Sciences* 30:2037–2081.
- CURRIE, P. J., AND X. ZHAO. 1993b. A new troodontid (Dinosauria, Theropoda) braincase from the Dinosaur Park Formation (Campanian) of Alberta. *Canadian Journal of Earth Sciences* 30:2231–2247.
- CZERKAS, S. A., AND Q. JI. 2002. A new rhamphorhynchoid with a headcrest and complex integumentary structures. Pages 15–41 *in* Feathered Dinosaurs and the Origin of Flight (S. J. Czerkas, Ed.). Dinosaur Museum Journal, vol. 1. Dinosaur Museum, Blanding, Utah.
- CZERKAS, S. A., AND C. YUAN. 2002. An arboreal maniraptoran from northeast China. Pages 63–95 *in* Feathered Dinosaurs and the Origin of Flight (S. J. Czerkas, Ed.). Dinosaur Museum Journal, vol. 1. Dinosaur Museum, Blanding, Utah.
- CZERKAS, S. A., D. ZHANG, J. LI, AND Y. LI. 2002. Flying dromaeosaurs. Pages 97–126 *in* Feathered Dinosaurs and the Origin of Flight (S. J. Czerkas,

- Ed.). Dinosaur Museum Journal, vol. 1. Dinosaur Museum, Blanding, Utah.
- DAHN, R. D., AND J. F. FALLON. 2000. Interdigital regulation of digit identity and homeotic transformation by modulated BMP signaling. *Science* 289:438–441.
- DE BEER, G. R. 1937. *The Development of the Vertebrate Skull*. Clarendon Press, Oxford, United Kingdom.
- DE BEER, G. R., AND E. J. W. BARRINGTON. 1934. The segmentation and chondrification of the skull of the duck. *Philosophical Transactions of the Royal Society of London, Series B* 223:411–467.
- DE PINNA, M. C. C. 1991. Concepts and tests of homology in the cladistic paradigm. *Cladistics* 7:367–394.
- DINGUS, L., AND T. ROWE. 1998. *The Mistaken Extinction: Dinosaur Evolution and the Origin of Birds*. W. H. Freeman, New York.
- DROSSOPOULOU, G., K. E. LEWIS, J. J. SANZ-EZQUERRO, N. NIKBAHKT, A. P. McMAHON, C. HOFMANN, AND C. TICKLE. 2000. A model for anteroposterior patterning of the vertebrate limb based on sequential long- and short-range Shh signalling and Bmp signalling. *Development* 127:1337–1348.
- ELZANOWSKI, A. 1999. A comparison of the jaw skeleton in theropods and birds, with a description of the palate in the Oviraptoridae. Pages 311–323 in *Avian Paleontology at the Close of the 20th Century: Proceedings of the 4th International Meeting of the Society of Avian Paleontology and Evolution* (S. L. Olson, Ed.). *Smithson Contributions in Paleobiology*, no. 89.
- ELZANOWSKI, A. 2002. Archaeopterygidae (Upper Jurassic of Germany). Pages 129–159 in *Mesozoic Birds: Above the Heads of Dinosaurs* (L. M. Chiappe and L. M. Witmer, Eds.). University of California Press, Berkeley.
- ELZANOWSKI, A., AND P. M. GALTON. 1991. Braincase of *Enaliornis*, an early Cretaceous bird from England. *Journal of Vertebrate Paleontology* 11:90–107.
- ELZANOWSKI, A., AND P. WELLNHOFFER. 1996. Cranial morphology of *Archaeopteryx*: Evidence from the seventh skeleton. *Journal of Vertebrate Paleontology* 16:81–94.
- EWER, R. F. 1965. The anatomy of the thecodont reptile *Euparkeria capensis* Broom. *Philosophical Transactions of the Royal Society of London, Series B* 248:379–435.
- FEDUCCIA, A. 1985. On why the dinosaur lacked feathers. Pages 75–79 in *The Beginnings of Birds: Proceedings of the International Archaeopteryx Conference Eichstatt 1984* (M. K. Hecht, J. H. Ostrom, G. Viohl, and P. Wellnhofer, Eds.). Freunde des Jura-Museums Eichstatt, Eichstatt.
- FEDUCCIA, A. 1993. Aerodynamic model for the early evolution of feathers provided by *Propithecus* (Primates, Lemuridae). *Journal of Theoretical Biology* 160:159–164.
- FEDUCCIA, A. 1995. The aerodynamic model for the evolution of feathers and feather misinterpretation. *Courier Forschungsinstitut Senckenberg* 181:65–77.
- FEDUCCIA, A. 1999. *The Origin and Evolution of Birds*, 2nd ed. Yale University Press, New Haven, Connecticut.
- FEDUCCIA, A. 2002. Birds are dinosaurs: Simple answer to a complex problem. *Auk* 119:1187–1201.
- FEDUCCIA, A. 2006. Mesozoic aviary takes form. *Proceedings of the National Academy of Sciences USA* 103:5–6.
- FEDUCCIA, A., T. LINGHAM-SOLIAR, AND J. R. HINCHLIFFE. 2005. Do feathered dinosaurs exist? Testing the hypothesis on neontological and paleontological evidence. *Journal of Morphology* 266:125–166.
- FEDUCCIA, A., L. D. MARTIN, AND S. TARSITANO. 2007. *Archaeopteryx* 2007: Quo vadis? *Auk* 124:373–380.
- FEDUCCIA, A., AND J. NOWICKI. 2002. The hand of birds revealed by early ostrich embryos. *Naturwissenschaften* 89:391–393.
- FEDUCCIA, A., AND R. WILD. 1993. Birdlike characters in the Triassic archosaur *Megalancosaurus*. *Naturwissenschaften* 80:564–566.
- FELSENSTEIN, J. 2001. The troubled growth of statistical phylogenetics. *Systematic Biology* 50:465–467.
- FELSENSTEIN, J. 2004. *Inferring Phylogenies*. Sinauer Associates, Sunderland, Massachusetts.
- FORSTER, C. A., S. D. SAMPSON, L. M. CHIAPPE, AND D. W. KRAUSE. 1998. The theropod ancestry of birds: New evidence from the Late Cretaceous of Madagascar. *Science* 279:1915–1919.
- GALIS, F., M. KUNDRÁT, AND J. A. J. METZ. 2005. Hox genes, digit identities, and the theropod/bird transition. *Journal of Experimental Zoology B* 304:198–205.
- GALIS, F., M. KUNDRÁT, AND B. SINERVO. 2003. An old controversy solved: Bird embryos have five fingers. *Trends in Ecology and Evolution* 18:7–9.
- GALTON, P. M. 1974. The ornithischian dinosaur *Hypsilophodon* from the Wealdon of the Isle of Wight. *Bulletin of the British Museum (Natural History), Geology Series* 251:1–152.
- GALTON, P. M., AND L. D. MARTIN. 2002. *Enaliornis*, an Early Cretaceous hesperornithiform bird from England with comments on other Hesperornithiformes. Pages 317–338 in *Mesozoic Birds: Above the Heads of Dinosaurs* (L. M. Chiappe and L. M. Witmer, Eds.). University of California Press, Berkeley.
- GAUTHIER, J. 1986. Saurischian monophyly and the origin of birds. *Memoirs of the California Academy of Sciences*, no. 8.
- GAUTHIER, J., AND L. F. GALL, Eds. 2001. *New Perspectives on the Origin and Early Evolution of Birds: Proceedings of the International Symposium in Honor of John H. Ostrom*. Yale University Press, New Haven, Connecticut.
- GAUTHIER, J. A., AND K. PADIAN. 1985. Phylogenetic, functional, and aerodynamic analyses of the origin of birds and their flight. Pages 185–197 in *The Beginnings of Birds: Proceedings of the International Archaeopteryx Conference Eichstatt 1984* (M. K. Hecht, J. H. Ostrom, G. Viohl, and P. Wellnhofer, Eds.). Freunde des Jura-Museums Eichstatt, Eichstatt.

- GISHLICK, A. D. 2001. The function of the manus and forelimb of *Deinonychus antirrhopus* and its importance for the origin of avian flight. Pages 301–318 in *New Perspectives on the Origin and Early Evolution of Birds: Proceedings of the International Symposium in Honor of John H. Ostrom* (J. Gauthier and L. F. Gall, Eds.). Yale University Press, New Haven, Connecticut.
- GÖHLICH, U. B., AND L. M. CHIAPPE. 2006. A new carnivorous dinosaur from the Late Jurassic Solnhofen archipelago. *Nature* 440:329–332.
- GOLDMAN, N., J. P. ANDERSON, AND A. G. RODRIGO. 2000. Likelihood-based tests of topologies in phylogenetics. *Systematic Biology* 49:652–670.
- GOLOBOFF, P. A. 1999. NONA, version 1.9. Published by the author, Fundación e Instituto Miguel Lillo, Tucuman, Argentina. [Online.] Available at www.cladistics.com/aboutNona.htm.
- GOSLINER, T. M., AND M. T. GHISELIN. 1984. Parallel evolution in opisthobranch gastropods and its implications for phylogenetic methodology. *Systematic Zoology* 33:255–274.
- GOULD, S. J., AND E. S. VRBA. 1982. Exaptation—A missing term in the science of form. *Paleobiology* 8:4–15.
- GOWER, D. J. 1997. The braincase of the early archosaurian reptile *Erythrosuchus africanus*. *Journal of Zoology* (London) 242:557–576.
- GOWER, D. J. 2001. Possible postcranial pneumaticity in the last common ancestor of birds and crocodylians: Evidence from *Erythrosuchus* and other Mesozoic archosaurs. *Naturwissenschaften* 88:119–122.
- GOWER, D. J. 2002. Braincase evolution in suchian archosaurs (Reptilia: Diapsida): Evidence from the rauisuchian *Batrachotomus kupferzellensis*. *Zoological Journal of the Linnean Society* 136:49–76.
- GOWER, D. J. 2003. Osteology of the early archosaurian reptile *Erythrosuchus africanus* Broom. *Annals of the South African Museum* 110:1–88.
- GOWER, D. J., AND A. D. WALKER. 2002. New data on the braincase of the aetosaurian archosaur (Reptilia: Diapsida) *Stagonolepis robertsoni* Agassiz. *Zoological Journal of the Linnean Society* 136:7–23.
- GOWER, D. J., AND E. WEBER. 1998. The braincase of *Euparkeria*, and the evolutionary relationships of birds and crocodylians. *Biological Reviews* 73:367–411.
- GOWER, D. J., AND M. WILKINSON. 1996. Is there any consensus on basal archosaur phylogeny? *Proceedings of the Royal Society of London, Series B* 263:1399–1406.
- HALL, B. K. 2001. Development of the clavicles in birds and mammals. *Journal of Experimental Zoology* 289:153–161.
- HARRIS, J. D., AND A. DOWNS. 2002. A drepanosaurid pectoral girdle from the Ghost Ranch (Whitaker) *Coeleophysis* quarry (Chinle Group, Rock Point Formation, Rhaetian), New Mexico. *Journal of Vertebrate Paleontology* 22:70–75.
- HAUGHTON, S. H. 1924. On a new type of thecodont from the Middle Beaufort beds. *Annals of the Transvaal Museum* 11:93–97.
- HECKERT, A. B., AND S. G. LUCAS. 2003. Clarifying aetosaur phylogeny requires more fossils, not more trees—Reply to Intraorganismal homology, character construction, and the phylogeny of the aetosaurian archosaurs (Reptilia: Diapsida). *Systematic Biology* 52:253–255.
- HEILMANN, G. 1926. *The Origin of Birds*. Witherby, London.
- HEMPEL, C. G. 1966. *Philosophy of Natural Science*. Prentice-Hall, Englewood Cliffs, New Jersey.
- HINCHLIFFE, J. R. 1985. “One, two, three” or “Two, three, four”: An embryologist’s view of the homologies of the digits and carpus of modern birds. Pages 141–147 in *The Beginnings of Birds: Proceedings of the International Archaeopteryx Conference Eichstatt 1984* (M. K. Hecht, J. H. Ostrom, G. Viohl, and P. Wellnhöfer, Eds.). Freunde des Jura-Museums Eichstatt, Eichstatt.
- HINCHLIFFE, J. R., AND M. K. HECHT. 1984. Homology of the bird wing skeleton: Embryological versus paleontological evidence. *Evolutionary Biology* 18:21–39.
- HOLDER, M. T., J. SUKUMARAN, AND P. O. LEWIS. 2008. A justification for reporting the majority-rule consensus tree in Bayesian phylogenetics. *Systematic Biology* 57:814–821.
- HOLMGREN, N. 1955. Studies on the phylogeny of birds. *Acta Zoologica* 36:243–328.
- HOLTZ, T. R., JR. 2000. A new phylogeny of the carnivorous dinosaurs. *Gaia* 15:5–61.
- HOLTZ, T. R., JR. 2001. Arctometatarsalia revisited: the problem of homoplasy in reconstructing theropod phylogeny. Pages 99–122 in *New Perspectives on the Origin and Early Evolution of Birds: Proceedings of the International Symposium in Honor of John H. Ostrom* (J. Gauthier and L. F. Gall, Eds.). Yale University Press, New Haven, Connecticut.
- HOLTZ, T. R., JR. 2004. Tyrannosauroidae. Pages 111–136 in *The Dinosauria*, 2nd ed. (D. B. Weishampel, P. Dodson, and H. Osmólska, Eds.). University of California Press, Berkeley.
- HOLTZ, T. R., JR., R. E. MOLNAR, AND P. J. CURRIE. 2004. Basal Tetanurae. Pages 71–110 in *The Dinosauria*, 2nd ed. (D. B. Weishampel, P. Dodson, and H. Osmólska, Eds.). University of California Press, Berkeley.
- HOU, L. H., L. D. MARTIN, Z. ZHOU, AND A. FEDUCCIA. 1999a. *Archaeopteryx* to opposite birds—Missing link from the Mesozoic of China. *Vertebrata Palasiatica* 37:88–95.
- HOU, L., L. D. MARTIN, Z. ZHOU, A. FEDUCCIA, AND F. ZHANG. 1999b. A diapsid skull in a new species of the primitive bird *Confuciusornis*. *Nature* 399:679–682.
- HOUCK, M. A., J. A. GAUTHIER, AND R. E. STRAUSS. 1990. Allometric scaling in the earliest fossil bird, *Archaeopteryx lithographica*. *Science* 247:195–198.

- HURUM, J. H. 2001. Lower jaw of *Gallimimus bullatus*. Pages 34–41 in *Mesozoic Vertebrate Life: New Research Inspired by the Paleontology of Philip J. Currie* (D. H. Tanke and K. Carpenter, Eds.). Indiana University Press, Bloomington.
- HWANG, S., M. A. NORELL, Q. JI, AND K. GAO. 2002. New specimens of *Microraptor zhaoianus* (Theropoda: Dromaeosauridae) from northeastern China. *American Museum Novitates* 3381:1–44.
- HWANG, S., M. A. NORELL, Q. JI, AND K. GAO. 2004. A large compsognathid from the Early Cretaceous Yixian Formation of China. *Journal of Systematic Palaeontology* 2:13–30.
- IORDANSKY, N. N. 1973. The skull of the Crocodylia. Pages 201–262 in *Biology of the Reptilia*, vol. 4 (C. Gans and T. S. Parsons, Eds.). Academic Press, London.
- JENNER, R. A. 2004. The scientific status of metazoan cladistics: Why current research practice must change. *Zoologica Scripta* 33:293–310.
- JI, Q., P. J. CURRIE, M. A. NORELL, AND S. JI. 1998. Two feathered dinosaurs from northeastern China. *Nature* 393:753–761.
- JI, Q., M. A. NORELL, K. Q. GAO, S. JI, AND D. REN. 2001. The distribution of integumentary structures in a feathered dinosaur. *Nature* 410:1084–1088.
- JI, Q., AND C. YUAN. 2002. Discovery of two kinds of protofeathered pterosaurs in the Mesozoic Daohugou biota in the Ningcheng region and its stratigraphic and biologic significances. [In Chinese.] *Geological Review* 48:221–224.
- JONES, T. D., J. A. RUBEN, P. F. A. MADERSON, AND L. D. MARTIN. 2001. *Longisquama* fossil and feather morphology: Response. *Science* 291:1901–1902.
- JONES, T. D., J. A. RUBEN, L. D. MARTIN, E. N. KUROCHKIN, A. FEDUCCIA, P. F. A. MADERSON, W. J. HILLENUS, N. R. GEIST, AND V. ALIFANOV. 2000. Non-avian feathers in a Late Triassic archosaur. *Science* 288:2202–2205.
- KEARNEY, M. 2002. Fragmentary taxa, missing data, and ambiguity: Mistaken assumptions and conclusions. *Systematic Biology* 51:369–381.
- KEARNEY, M., AND J. M. CLARK. 2003. Problems due to missing data in phylogenetic analyses including fossils: A critical review. *Journal of Vertebrate Paleontology* 23:263–274.
- KEARNEY, M., AND O. RIEPPEL. 2006. Rejecting “the given” in systematics. *Cladistics* 22:369–377.
- KIRKLAND, J. I., D. K. SMITH, AND D. G. WOLFE. 2005a. Holotype braincase of *Nothronychus mckinleyi* Kirkland and Wolfe 2001 (Theropoda; Therizinosauroida) from the Upper Cretaceous (Turonian) of west-central New Mexico. Pages 87–96 in *The Carnivorous Dinosaurs* (K. Carpenter, Ed.). Indiana University Press, Bloomington.
- KIRKLAND, J. I., AND D. G. WOLFE. 2001. First definitive therizinosaurid (Dinosauria; Theropoda) from North America. *Journal of Vertebrate Paleontology* 21:410–414.
- KIRKLAND, J. I., L. E. ZANNO, S. D. SAMPSON, J. M. CLARK, AND D. D. DEBLIEUX. 2005b. A primitive therizinosauroid dinosaur from the Early Cretaceous of Utah. *Nature* 435:84–87.
- KISHINO, H., AND M. HASEGAWA. 1989. Evaluation of the maximum likelihood estimate of the evolutionary tree topologies from DNA sequence data, and the branching order in Hominoidea. *Journal of Molecular Evolution* 29:170–179.
- KLUGE, A. G. 1997. Testability and the refutation and corroboration of cladistic hypotheses. *Cladistics* 13:81–96.
- KLUGE, A. G. 1999. The science of phylogenetic systematics: Explanation, prediction, and test. *Cladistics* 15:429–436.
- KLUGE, A. G. 2001. Philosophical conjectures and their refutation. *Systematic Biology* 50:322–330.
- KOBAYASHI, Y., AND R. BARSBOLD. 2005. Anatomy of *Harpymimus okladnikov* Barsbold and Perle 1984 (Dinosauria: Theropoda) of Mongolia. Pages 97–126 in *The Carnivorous Dinosaurs* (K. Carpenter, Ed.). Indiana University Press, Bloomington.
- KOBAYASHI, Y., AND J. LÜ. 2003. A new ornithomimid dinosaur with gregarious habits from the Late Cretaceous of China. *Acta Palaeontologica Polonica* 48:235–259.
- KUHN, T. S. 1970. *The Structure of Scientific Revolutions*, 2nd ed. University of Chicago Press, Chicago, Illinois.
- KUNDRÁT, M. 2008. Primary chondrification foci in the wing basipodium of *Struthio camelus* with comments on interpretation of autopodial elements in Crocodylia and Aves. *Journal of Experimental Zoology B* 310:1–12.
- KUNDRÁT, M., V. SEICHERT, A. P. RUSSELL, AND K. SMETANA, JR. 2002. Pentadactyl pattern of the avian wing autopodium and pyramid reduction hypothesis. *Journal of Experimental Zoology B* 294:152–159.
- KUROCHKIN, E. N. 2006a. Basal diversification of Aves. Pages 219–232 in *Evolution of the Biosphere and Biodiversity: To 70 Years of A. Yu. Rozanov* (S. V. Rozhnov, Ed.). [In Russian.] Toravirtzestvo Scientific Editions KMK, Moscow.
- KUROCHKIN, E. N. 2006b. Parallel evolution of theropod dinosaurs and birds. [In Russian.] *Zoologicheskii Zhurnal* 85:283–297 [English version, *Entomological Review* 86, 545–558].
- KURZANOV, S. M. 1982. Structural characteristics of the forelimbs of *Avimimus*. *Paleontological Journal* 16:108–112.
- KURZANOV, S. M. 1983. New data on the pelvic structure of *Avimimus*. *Paleontological Journal* 17:110–111.
- KURZANOV, S. M. 1985. The skull structure of the dinosaur *Avimimus*. *Paleontological Journal* 19:92–99.
- LANGER, M. C. 2004. Basal Saurischia. Pages 25–46 in *The Dinosauria*, 2nd ed. (D. B. Weishampel, P. Dodson, and H. Osmólska, Eds.). University of California Press, Berkeley.

- LARSSON, H. C. E., AND G. P. WAGNER. 2002. Pentadactyl ground state of the avian wing. *Journal of Experimental Zoology B* 294:146–151.
- LARSSON, H. C. E., AND G. P. WAGNER. 2003. Old morphologies misinterpreted. *Trends in Ecology and Evolution* 18:10.
- LINGHAM-SOLIAR, T. 2003a. Evolution of birds: Ichthyosaur integumental fibers conform to dromaeosaur protofeathers. *Naturwissenschaften* 90:428–432.
- LINGHAM-SOLIAR, T. 2003b. The dinosaurian origin of feathers: Perspectives from dolphin (Cetacea) collagen fibers. *Naturwissenschaften* 90:563–567.
- LINGHAM-SOLIAR, T., A. FEDUCCIA, AND X. WANG. 2007. A new Chinese specimen indicates that 'protofeathers' in the Early Cretaceous theropod dinosaur *Sinosauropteryx* are degraded collagen fibres. *Proceedings of the Royal Society of London, Series B* 274:1823–1829.
- LINGHAM-SOLIAR, T., AND J. WESLEY-SMITH. 2008. First investigation of the collagen D-band ultrastructure in fossilized vertebrate integument. *Proceedings of the Royal Society of London, Series B* 275:2207–2212.
- LIVEZEY, B. C. 1998. A phylogenetic analysis of the Gruiformes (Aves) based on morphological characters, with an emphasis on the rails (Rallidae). *Philosophical Transactions of the Royal Society of London, Series B* 353:2077–2151.
- LIVEZEY, B. C. 2003. Evolution of flightlessness in rails (Gruiformes: Rallidae): Phylogenetic, ecomorphological, and ontogenetic perspectives. *Ornithological Monographs*, no. 53.
- LIVEZEY, B. C., AND R. L. ZUSI. 2006. Higher-order phylogeny of modern birds (Theropoda, Aves: Neornithes) based on comparative anatomy: I. Methods and characters. *Bulletin of the Carnegie Museum of Natural History*, no. 37.
- LONGRICH, N. 2006. Structure and function of hindlimb feathers in *Archaeopteryx lithographica*. *Paleobiology* 32:417–431.
- LÜ, J. 2002. A new oviraptorosaurid (Theropoda: Oviraptorosauria) from the Late Cretaceous of southern China. *Journal of Vertebrate Paleontology* 22:871–875.
- LÜ, J., Z. DONG, Y. AZUMA, R. BARSBOLD, AND Y. TOMIDA. 2002. Oviraptorosaurs compared to birds. Pages 175–189 in *Proceedings of the 5th Symposium of the Society of Avian Paleontology and Evolution* (Z. Zhou and F. Zhang, Eds.). Science Press, Beijing.
- LÜ, J., D. HUANG, AND L. QIU. 2005. The pectoral girdle and the forelimb of *Heyuanmia* (Dinosauria: Oviraptorosauria). Pages 256–273 in *The Carnivorous Dinosaurs* (K. Carpenter, Ed.). Indiana University Press, Bloomington.
- MADERSON, P. F. A., AND L. ALIBARDI. 2000. The development of the sauropsid integument: A contribution to the problem of the origin and evolution of feathers. *American Zoologist* 40:513–529.
- MADSEN, J. H., JR. 1993. *Allosaurus fragilis*: A revised osteology. [Reprint.] Utah Geological Survey Bulletin, no. 109.
- MADSEN, J. H., JR., AND S. P. WELLES. 2000. *Ceratosaurus* (Dinosauria, Theropoda): A Revised Osteology. Utah Geological Survey, Salt Lake City.
- MAKOVICKY, P., AND P. J. CURRIE. 1998. The presence of a furcula in tyrannosaurid theropods, and its phylogenetic and functional implications. *Journal of Vertebrate Paleontology* 18:143–149.
- MAKOVICKY, P. J., AND G. J. DYKE. 2001. Naive falsification and the origin of birds. Pages 501–510 in *New Perspectives on the Origin and Early Evolution of Birds: Proceedings of the International Symposium in Honor of John H. Ostrom* (J. Gauthier and L. F. Gall, Eds.). Yale University Press, New Haven, Connecticut.
- MAKOVICKY, P., Y. KOBAYASHI, AND P. J. CURRIE. 2004. Ornithomimosauria. Pages 137–150 in *The Dinosauria*, 2nd ed. (D. B. Weishampel, P. Dodson, and H. Osmólska, Eds.). University of California Press, Berkeley.
- MAKOVICKY, P., AND M. A. NORELL. 2004. Troodontidae. Pages 184–195 in *The Dinosauria*, 2nd ed. (D. B. Weishampel, P. Dodson, and H. Osmólska, Eds.). University of California Press, Berkeley.
- MAKOVICKY, P. J., M. A. NORELL, J. M. CLARK, AND T. ROWE. 2003. Osteology and relationships of *Byronosaurus jaffei* (Theropoda: Troodontidae). *American Museum Novitates* 3402:1–32.
- MAKOVICKY, P., AND H.-D. SUES. 1998. Anatomy and phylogenetic relationships of the theropod dinosaur *Microvenator celer* from the Lower Cretaceous of Montana. *American Museum Novitates* 3240:1–27.
- MARSH, O. C. 1880. *Odontornithes: A Monograph on the Extinct Toothed Birds of North America*. United States Geological Exploration of the 40th Parallel. U.S. Government Printing Office, Washington, D.C.
- MARTIN, L. D. 1983. The origin of birds and of avian flight. Pages 105–129 in *Current Ornithology*, vol. 1 (R. F. Johnston, Ed.). Plenum Press, New York.
- MARTIN, L. D. 1985. The relationship of *Archaeopteryx* to other birds. Pages 177–183 in *The Beginnings of Birds: Proceedings of the International Archaeopteryx Conference Eichstatt 1984* (M. K. Hecht, J. H. Ostrom, G. Viohl, and P. Wellnhofer, Eds.). Freunde des Jura-Museums Eichstatt, Eichstatt.
- MARTIN, L. D. 1991. Mesozoic birds and the origin of birds. Pages 485–540 in *Origins of the Higher Groups of Tetrapods: Controversy and Consensus* (H.-P. Schultze and L. Trueb, Eds.). Cornell University Press, Ithaca, New York.
- MARTIN, L. D. 1995. A new skeletal model of *Archaeopteryx*. *Archaeopteryx* 13:33–40.
- MARTIN, L. D. 2004. A basal archosaurian origin of birds. *Acta Zoologica Sinica* 50:978–990.
- MARTIN, L. D., AND O. BONNER. 1977. An immature specimen of *Baptornis advenus* from the Cretaceous of Kansas. *Auk* 94:787–789.

- MARTIN, L. D., AND S. A. CZERKAS. 2000. The fossil record of feather evolution in the Mesozoic. *American Zoologist* 40:687–694.
- MARTIN, L. D., V. L. NAPLES, AND Z. ZHOU. 1998a. The furcula in early birds. *Journal of Vertebrate Paleontology* 18(Supplement 3):60A–61A.
- MARTIN, L. D., AND J. D. STEWART. 1977. Teeth in *Ichthyornis* (Class: Aves). *Nature* 195:1331–1332.
- MARTIN, L. D., AND J. D. STEWART. 1985. Homologies in the avian tarsus. *Nature* 315:159–160.
- MARTIN, L. D., AND J. D. STEWART. 1999. Implantation and replacement of bird teeth. *Smithsonian Contributions to Paleobiology* 89:295–300.
- MARTIN, L. D., J. D. STEWART, AND K. N. WHETSTONE. 1980. The origin of birds: Structure of the tarsus and teeth. *Auk* 97:86–93.
- MARTIN, L. D., AND J. TATE, JR. 1976. The skeleton of *Baptornis advenus*. *Smithsonian Contributions to Paleobiology* 27:35–66.
- MARTIN, L. D., AND Z. ZHOU. 1997. *Archaeopteryx*-like skull in enantiornithine bird. *Nature* 389:556.
- MARTIN, L. D., Z. ZHOU, L. HOU, AND A. FEDUCCIA. 1998b. *Confuciusornis sanctus* compared to *Archaeopteryx lithographica*. *Naturwissenschaften* 85:286–289.
- MARYAŃSKA, T., H. OSMÓLSKA, AND M. WOLSAN. 2002. Avialan status for Oviraptorosauria. *Acta Palaeontologica Polonica* 47:97–116.
- MAYR, G., B. POHL, S. HARTMAN, AND D. S. PETERS. 2007. The tenth skeletal specimen of *Archaeopteryx*. *Zoological Journal of the Linnean Society* 149:97–116.
- MAYR, G., B. POHL, AND D. S. PETERS. 2005. A well-preserved *Archaeopteryx* specimen with theropod features. *Science* 310:1483–1486.
- MCDOWELL, S. 1978. Homology mapping of the primitive archosaurian reptile palate on the palate of birds. *Evolutionary Theory* 4:81–94.
- MCGOWAN, C. 1984. Evolutionary relationships of ratites and carinates: Evidence from ontogeny of the tarsus. *Nature* 307:733–735.
- MCGOWAN, C. 1985. Homologies in the avian tarsus. *Nature* 315:160.
- MONTAGNA, W. 1945. A re-investigation of the development of the wing of the fowl. *Journal of Morphology* 76:87–113.
- MOOK, C. C. 1921. Notes on the postcranial skeleton in the Crocodylia. *Bulletin of the American Museum of Natural History* 44:67–99.
- MORSE, E. S. 1872. On the tarsus and carpus of birds. *Annals of the Lyceum of Natural History* 10:1–22.
- MURRAY, P. F., AND P. VICKERS-RICH. 2004. *Magnificent Mihirungs: The Colossal Flightless Birds of the Australian Dreamtime*. Indiana University Press, Bloomington.
- NAPLES, V. L., L. D. MARTIN, AND J. SIMMONS. 2002. The pelvis in early birds and dinosaurs. Pages 203–210 in *Proceedings of the 5th Symposium of the Society of Avian Paleontology and Evolution* (Z. Zhou and F. Zhang, Eds.). Science Press, Beijing.
- NAYLOR, G. J. P., AND D. C. ADAMS. 2001. Are the fossil data really at odds with the molecular data? Morphological evidence for Cetartiodactyla phylogeny reexamined. *Systematic Biology* 50:444–453.
- NESBITT, S. J. 2007. The anatomy of *Effigia okeeffeae* (Archosauria, Suchia), theropod-like convergence, and the distribution of related taxa. *Bulletin of the American Museum of Natural History* 302:1–84.
- NESBITT, S. J., AND M. A. NORELL. 2006. Extreme convergence in the body plans of an early suchian (Archosauria) and ornithomimid dinosaurs (Theropoda). *Proceedings of the Royal Society of London, Series B* 273:1045–1048.
- NICHOLLS, E. L., AND A. P. RUSSELL. 1985. Structure and function of the pectoral girdle and forelimb of *Struthiomimus altus* (Theropoda: Ornithomimidae). *Palaeontology* 28:643–677.
- NIXON, K. C., AND J. M. CARPENTER. 1993. On outgroups. *Cladistics* 9:413–426.
- NORELL, M. A., J. CLARK, AND P. J. MAKOVICKY. 2001. Phylogenetic relationships among coelurosaurian theropods. Pages 49–67 in *New Perspectives on the Origin and Early Evolution of Birds: Proceedings of the International Symposium in Honor of John H. Ostrom* (J. Gauthier and L. F. Gall, Eds.). Yale University Press, New Haven, Connecticut.
- NORELL, M. A., AND M. ELLISON. 2005. *Unearthing the Dragon: The Great Feathered Dinosaur Discovery*. Pi Press, New York.
- NORELL, M. A., AND S. H. HWANG. 2004. A troodontid dinosaur from Ukhaa Tolgod (Late Cretaceous Mongolia). *American Museum Novitates* 3446:1–9.
- NORELL, M. A., AND P. J. MAKOVICKY. 1997. Important features of the dromaeosaur skeleton: Information from a new specimen. *American Museum Novitates* 3215:1–28.
- NORELL, M. A., AND P. J. MAKOVICKY. 1999. Important features of the dromaeosaurid skeleton II: Information from newly collected specimens of *Velociraptor mongoliensis*. *American Museum Novitates* 3282:1–43.
- NORELL, M. A., AND P. J. MAKOVICKY. 2004. Dromaeosauridae. Pages 196–209 in *The Dinosauria*, 2nd ed. (D. B. Weishampel, P. Dodson, and H. Osmólska, Eds.). University of California Press, Berkeley.
- NORELL, M. A., P. J. MAKOVICKY, AND J. M. CLARK. 2000. A new troodontid from Ukhaa Tolgod, Mongolia. *Journal of Vertebrate Paleontology* 20:7–11.
- NORELL, M. A., AND X. XU. 2005. Feathered dinosaurs. *Annual Review of Earth and Planetary Sciences* 33:277–299.
- NORMAN, D. B. 1990. Problematic Theropoda: “Coelurosauria.” Pages 280–305 in *The Dinosauria* (D. B. Weishampel, P. Dodson, and H. Osmólska, Eds.). University of California Press, Berkeley.
- NOVAS, F. E. 1993. New information on the systematics and postcranial skeleton of *Herrerasaurus*

- ischigualastensis* (Theropoda: Herrerasauridae) from the Ischigualasto Formation (Upper Triassic) of Argentina. *Journal of Vertebrate Paleontology* 13:400–423.
- NOVAS, F. E., AND D. POL. 2002. Alvarezsaurid relationships reconsidered. Pages 121–125 in *Mesozoic Birds: Above the Heads of Dinosaurs* (L. M. Chiappe and L. M. Witmer, Eds.). University of California Press, Berkeley.
- NOVAS, F. E., AND P. F. PUERTA. 1997. New evidence concerning avian origins from the Late Cretaceous of Patagonia. *Nature* 387:390–392.
- OSMÓLSKA, H., P. J. CURRIE, AND R. BARSBOLD. 2004. Oviraptorosauria. Pages 165–183 in *The Dinosauria*, 2nd ed. (D. B. Weishampel, P. Dodson, and H. Osmólska, Eds.). University of California Press, Berkeley.
- OSMÓLSKA, H., E. RONEWICZ, AND R. BARSBOLD. 1972. A new dinosaur, *Gallimimus bullatus* n. gen., n. sp. (Ornithomimidae) from the Upper Cretaceous of Mongolia. *Palaeontologia Polonica* 27:103–143.
- OSTROM, J. H. 1969. Osteology of *Deinonychus antirrhopus*, an unusual theropod from the Lower Cretaceous of Montana. *Bulletin of the Peabody Museum of Natural History*, no. 30.
- OSTROM, J. H. 1973. The ancestry of birds. *Nature* 242:136.
- OSTROM, J. H. 1974. The pectoral girdle and forelimb function of *Deinonychus* (Reptilia: Saurischia): A correction. *Postilla* 165:1–11.
- OSTROM, J. H. 1975. The origin of birds. *Annual Review of Earth and Planetary Sciences* 3:55–77.
- OSTROM, J. H. 1976a. *Archaeopteryx* and the origin of birds. *Biological Journal of the Linnean Society* 8:91–182.
- OSTROM, J. H. 1976b. Some hypothetical anatomical stages in the evolution of avian flight. *Smithsonian Contributions to Paleobiology* 27:1–21.
- OSTROM, J. H. 1978. The osteology of *Compsognathus longipes* Wagner. *Zitteliana* 4:73–118.
- OSTROM, J. H. 1985. The meaning of *Archaeopteryx*. Pages 161–176 in *The Beginnings of Birds: Proceedings of the International Archaeopteryx Conference Eichstatt 1984* (M. K. Hecht, J. H. Ostrom, G. Viohl, and P. Wellnhofer, Eds.). Freunde des Jura Museums Eichstatt, Eichstatt.
- OWEN, R. 1850. On the communication between the cavity of the tympanum and the palate in the Crocodilia (gavials, alligators and crocodiles). *Philosophical Transactions of the Royal Society of London* 140:521–527.
- PADIAN, K. 1982. Macroevolution and the origin of major adaptations: Vertebrate flight as a paradigm for the analysis of patterns. Pages 387–392 in *Proceedings of the Third North American Paleontological Convention*, vol. 2 (B. L. Mamet and M. J. Copeland, Eds.). Business and Economic Service, Toronto, Ontario.
- PADIAN, K. 2001a. Stages in the origin of bird flight: Beyond the arboreal–cursorial dichotomy. Pages 255–272 in *New Perspectives on the Origin and Early Evolution of Birds: Proceedings of the International Symposium in Honor of John H. Ostrom* (J. Gauthier and L. F. Gall, Eds.). Yale University Press, New Haven, Connecticut.
- PADIAN, K. 2001b. The false issues of bird origins: An historiographic perspective. Pages 485–499 in *New Perspectives on the Origin and Early Evolution of Birds: Proceedings of the International Symposium in Honor of John H. Ostrom* (J. Gauthier and L. F. Gall, Eds.). Yale University Press, New Haven, Connecticut.
- PADIAN, K. 2004. Basal Avialae. Pages 210–231 in *The Dinosauria*, 2nd ed. (D. B. Weishampel, P. Dodson, and H. Osmólska, Eds.). University of California Press, Berkeley.
- PADIAN, K., AND L. M. CHIAPPE. 1998. The origin and early evolution of birds. *Biological Reviews* 73:1–42.
- PADIAN, K., Q. JI, AND S. JI. 2001. Feathered dinosaurs and the origin of flight. Pages 117–135 in *Mesozoic Vertebrate Life: New Research Inspired by the Paleontology of Philip J. Currie* (D. H. Tanke and K. Carpenter, Eds.). Indiana University Press, Bloomington.
- PARKER, W. K. 1891. On the morphology of a reptilian bird *Opisthocomus cristatus*. *Transactions of the Zoological Society of London* 13:43–85.
- PARRISH, J. M. 1993. Phylogeny of the Crocodylotarsi, with reference to archosaurian and crurotarsan monophyly. *Journal of Vertebrate Paleontology* 13:287–308.
- PAUL, G. S. 2002. *Dinosaurs of the Air: The Evolution and Loss of Flight in Dinosaurs and Birds*. Johns Hopkins University Press, Baltimore, Maryland.
- PÉREZ-MORENO, B. P., J. L. SANZ, A. D. BUSCALIONI, J. J. MORATALLA, F. ORTEGA, AND D. RASSKIN-GUTMAN. 1994. A unique multitoothed ornithomimosaur dinosaur from the Lower Cretaceous of Spain. *Nature* 370:363–367.
- PERLE, A., L. M. CHIAPPE, R. BARSBOLD, J. M. CLARK, AND M. A. NORELL. 1994. Skeletal morphology of *Mononykus olecranus* (Theropoda: Avialae) from the Late Cretaceous of Mongolia. *American Museum Novitates* 3105:1–29.
- PERLE, A., M. A. NORELL, L. M. CHIAPPE, AND J. M. CLARK. 1993. Flightless bird from the Cretaceous of Mongolia. *Nature* 362:623–626.
- PEYER, K. 2006. A reconsideration of *Compsognathus* from the Upper Tithonian of Canjuers, southeastern France. *Journal of Vertebrate Paleontology* 24:879–896.
- POPPER, K. R. 1998. *Conjectures and Refutations: The Growth of Scientific Knowledge*, 5th ed. Routledge, New York.
- POPPER, K. R. 2002. *The Logic of Scientific Discovery*. Routledge, New York.

- PRUM, R. O. 1999. Development and evolutionary origin of feathers. *Journal of Experimental Zoology B* 285:291–306.
- PRUM, R. O. 2002. Why ornithologists should care about the theropod origin of birds. *Auk* 119:1–17.
- PRUM, R. O. 2003. Are current critiques of the theropod origin of birds science? Rebuttal to Feduccia (2002). *Auk* 120:550–561.
- PRUM, R. O., AND A. H. BRUSH. 2002. The evolutionary origin and diversification of feathers. *Quarterly Review of Biology* 77:261–295.
- PRUM, R. O., AND J. DYCK. 2003. A hierarchical model of plumage: Morphology, development, and evolution. *Journal of Experimental Zoology B* 298:73–90.
- PRUM, R. O. 2001. *Longisquama* fossil and feather morphology. *Science* 291:1899–1900.
- RAATH, M. A. 1985. The theropod *Syntarsus* and its bearings on the origin of birds. Pages 219–227 in *The Beginnings of Birds: Proceedings of the International Archaeopteryx Conference Eichstatt 1984* (M. K. Hecht, J. H. Ostrom, G. Viohl, and P. Wellnhofer, Eds.). Freunde des Jura-Museums Eichstatt, Eichstatt.
- REESE, A. M. 1915. *The Alligator and Its Allies*. Knickerbocker Press, New York.
- Rieppel, O. 1985. The recessus scalae tympani and its bearing on the classification of reptiles. *Journal of Herpetology* 19:373–384.
- RIEPEL, O., AND M. KEARNEY. 2002. Similarity. *Biological Journal of the Linnean Society* 75:59–82.
- ROMANOFF, A. L. 1960. *The Avian Embryo: Structural and Functional Development*. Macmillan, New York.
- ROMER, A. 1956. *Osteology of the Reptiles*. University of Chicago Press, Chicago, Illinois.
- ROSE, M. R., AND G. V. LAUDER. 1996. Post-spandrel adaptationism. Pages 1–8 in *Adaptation* (M. R. Rose and G. V. Lauder, Eds.). Academic Press, San Diego, California.
- ROWE, T., AND J. GAUTHIER. 1990. Ceratosauria. Pages 151–168 in *The Dinosauria* (D. B. Weishampel, P. Dodson, and H. Osmólska, Eds.). University of California Press, Berkeley.
- RUBEN, J. A., AND T. D. JONES. 2000. Selective factors associated with the origin of fur and feathers. *American Zoologist* 40:585–596.
- RUSSELL, A. P., AND D. J. JOFFE. 1985. The early development of the quail (*Coturnix c. japonica*) furcula reconsidered. *Journal of Zoology (London)* 206:69–81.
- RUSSELL, D. A., AND Z. DONG. 1993a. A nearly complete skeleton of a new troodontid dinosaur from the Early Cretaceous of the Ordos Basin, Inner Mongolia, People's Republic of China. *Canadian Journal of Earth Sciences* 30:2163–2173.
- RUSSELL, D. A., AND Z. DONG. 1993b. The affinities of a new theropod from the Alxa Desert, Inner Mongolia, People's Republic of China. *Canadian Journal of Earth Sciences* 30:2107–2127.
- SANDERSON, M. J., AND H. B. SHAFFER. 2002. Troubleshooting molecular phylogenetic analyses. *Annual Review of Ecology and Systematics* 33:49–72.
- SANZ, J. L., AND J. F. BONAPARTE. 1992. A new order of birds (Class Aves) from the Lower Cretaceous of Spain. *Natural History Museum of Los Angeles County Scientific Series* 36:39–49.
- SANZ, J. L., L. M. CHIAPPE, B. P. PÉREZ-MORENO, J. J. MORATALLA, F. HERNÁNDEZ-CARRASQUILLA, A. D. BUSCALIONI, F. ORTEGA, F. J. POYATO-ARIZA, D. RASSKIN-GUTMAN, AND X. MARTÍNEZ-DELCLÓS. 1997. A nestling bird from the Early Cretaceous of Spain: Implications for avian skull and neck evolution. *Science* 276:1543–1546.
- SANZ, J. L., B. P. PÉREZ-MORENO, L. M. CHIAPPE, AND A. D. BUSCALIONI. 2002. The birds from the Lower Cretaceous of Las Hoyas (Province of Cuenca, Spain). Pages 209–229 in *Mesozoic Birds: Above the Heads of Dinosaurs* (L. M. Chiappe and L. M. Witmer, Eds.). University of California Press, Berkeley.
- SAWYER, R. H., AND L. W. KNAPP. 2003. Avian skin development and the evolutionary origin of feathers. *Journal of Experimental Zoology B* 298:57–72.
- SAWYER, R. H., B. A. SALVATORE, T. F. POTYLICKI, J. O. FRENCH, T. C. GLENN, AND L. W. KNAPP. 2003a. Origin of feathers: Feather beta (β) keratins are expressed in discrete epidermal cell populations of embryonic scutate scales. *Journal of Experimental Zoology B* 295:12–24.
- SAWYER, R. H., L. D. WASHINGTON, B. A. SALVATORE, T. C. GLENN, AND L. W. KNAPP. 2003b. Origin of archosaurian integumentary appendages: The bristles of the wild turkey beard express feather-type β keratins. *Journal of Experimental Zoology B* 297:27–34.
- SCHWEITZER, M. H. 2001. Evolutionary implications of possible protofeather structures associated with a specimen of *Shuvuuia deserti*. Pages 181–192 in *New Perspectives on the Origin and Early Evolution of Birds: Proceedings of the International Symposium in Honor of John H. Ostrom* (J. Gauthier and L. F. Gall, Eds.). Yale University Press, New Haven, Connecticut.
- SCHWEITZER, M. H., J. A. WATT, R. AVCI, L. KNAPP, L. M. CHIAPPE, M. A. NORELL, AND M. MARSHALL. 1999. Beta-keratin specific immunological reactivity in feather-like structures of the Cretaceous alvarezsaurid, *Shuvuuia deserti*. *Journal of Experimental Zoology B* 285:146–157.
- SENER, P. 2004. Phylogeny of Drepanosauridae (Reptilia: Diapsida). *Journal of Systematic Paleontology* 2:257–268.
- SENER, P., R. BARSBOLD, B. B. BRITT, AND D. A. BURNHAM. 2004. Systematics and evolution of Dromaeosauridae (Dinosauria: Theropoda). *Bulletin of the Gunma Museum of Natural History* 8:1–20.
- SENER, P., AND J. H. ROBINS. 2003. Taxonomic status of the specimens of *Archaeopteryx*. *Journal of Vertebrate Paleontology* 23:961–965.

- SERENO, P. C. 1991. Basal archosaurs: Phylogenetic relationships and functional implications. Society for Vertebrate Paleontology Memoirs, no. 2.
- SERENO, P. C. 1993. The pectoral girdle and forelimb of the basal theropod *Herrerasaurus ischigualastensis*. *Journal of Vertebrate Paleontology* 13:425–450.
- SERENO, P. C. 1999. The evolution of dinosaurs. *Science* 284:2137–2147.
- SERENO, P. C. 2001. Alvarezsaurids: Birds or ornithomimosaurs? Pages 69–98 in *New Perspectives on the Origin and Early Evolution of Birds: Proceedings of the International Symposium in Honor of John H. Ostrom* (J. Gauthier and L. F. Gall, Eds.). Yale University Press, New Haven, Connecticut.
- SERENO, P. C. 2007. The phylogenetic relationships of early dinosaurs: A comparative report. *Histoire de la Biologie (Paris)* 19:145–155.
- SERENO, P. C., AND A. B. ARCUCCI. 1994. Dinosaurian precursors from the Middle Triassic of Argentina: *Marasuchus lilloensis*, gen. nov. *Journal of Vertebrate Paleontology* 14:53–73.
- SERENO, P. C., AND F. E. NOVAS. 1993. The skull and neck of the basal theropod *Herrerasaurus ischigualastensis*. *Journal of Vertebrate Paleontology* 13:451–476.
- SERENO, P. C., C. RAO, AND J. LI. 2002. *Sinornis santensis* (Aves: Enantiornithes) from the early Cretaceous of northeastern China. Pages 184–208 in *Mesozoic Birds: Above the Heads of Dinosaurs* (L. M. Chiappe and L. M. Witmer, Eds.). University of California Press, Berkeley.
- SERENO, P. C., J. A. WILSON, H. C. LARSSON, D. B. DUTHEIL, AND H.-D. SUES. 1994. Early Cretaceous dinosaurs from the Sahara. *Science* 266:267–271.
- SHAROV, A. G. 1970. An unusual reptile from the Lower Triassic of Fergana. *Paleontological Journal* 1970:112–116.
- STEEL, M., AND D. PENNY. 2000. Parsimony, likelihood, and the role of models in molecular phylogenetics. *Molecular Biology and Evolution* 17:839–850.
- SUES, H.-D., P. E. OLSEN, J. G. CARTER, AND D. M. SCOTT. 2003. A new crocodylomorph archosaur from the Upper Triassic of North Carolina. *Journal of Vertebrate Paleontology* 23:329–343.
- SUZUKI, S., L. M. CHIAPPE, G. J. DYKE, M. WATABE, R. BARSBOLD, AND K. TSOGTBAATAR. 2002. A new specimen of *Shuvuuia deserti* Chiappe et al. 1998 from the Mongolian Late Cretaceous with a discussion of the relationships of alvarezsaurids to other theropod dinosaurs. *Natural History Museum of Los Angeles County Scientific Series*, no. 494.
- SWOFFORD, D. L. 2003. PAUP*: Phylogenetic Analysis Using Parsimony (*and Other Methods), version 4.0b10. Sinauer Associates, Sunderland, Massachusetts.
- SWOFFORD, D. L., G. J. OLSEN, P. J. WADDELL, AND D. M. HILLIS. 1996. Phylogenetic inference. Pages 407–514 in *Molecular Systematics*, 2nd ed. (D. M. Hillis, C. Moritz, and B. K. Mable, Eds.). Sinauer Associates, Sunderland, Massachusetts.
- TARSITANO, S. 1991. *Archaeopteryx*: Quo vadis? Pages 541–576 in *Origins of the Higher Groups of Tetrapods: Controversy and Consensus* (H.-P. Schultze and L. Trueb, Eds.). Cornell University Press, Ithaca, New York.
- TARSITANO, S., AND M. K. HECHT. 1980. A reconsideration of the reptilian relationships of *Archaeopteryx*. *Zoological Journal of the Linnean Society* 69:149–182.
- TURNER, A. H., D. POL, J. A. CLARKE, G. M. ERICKSON, AND M. A. NORELL. 2007. A basal dromaeosaurid and size evolution preceding avian flight. *Science* 317:1378–1381.
- TYKOSKI, R. S., AND T. ROWE. 2004. Ceratosauria. Pages 47–70 in *The Dinosauria*, 2nd ed. (D. B. Weishampel, P. Dodson, and H. Osmólska, Eds.). University of California Press, Berkeley.
- UNWIN, D. M. 2006. *The Pterosaurs: From Deep Time*. Pi Press, New York.
- UNWIN, D. M., AND N. N. BAKHURINA. 1994. *Sordes pilosus* and the nature of the pterosaur flight apparatus. *Nature* 371:62–64.
- UNWIN, D. M., AND M. J. BENTON. 2001. *Longisquama* fossil and feather morphology. *Science* 291:1899.
- UPCHURCH, P., P. M. BARRETT, AND P. DODSON. 2004. Sauropoda. Pages 259–324 in *The Dinosauria*, 2nd ed. (D. B. Weishampel, P. Dodson, and H. Osmólska, Eds.). University of California Press, Berkeley.
- VARGAS, A. O., AND J. F. FALLON. 2005a. Birds have dinosaur wings: The molecular evidence. *Journal of Experimental Zoology B* 304:85–89.
- VARGAS, A. O., AND J. F. FALLON. 2005b. The digits of the wing of birds are 1, 2, and 3. A review. *Journal of Experimental Zoology B* 304:206–219.
- VICKERS-RICH, P., L. M. CHIAPPE, AND S. KURZANOV. 2002. The enigmatic birdlike dinosaur *Avimimus portentosus*. Pages 65–86 in *Mesozoic Birds: Above the Heads of Dinosaurs* (L. M. Chiappe and L. M. Witmer, Eds.). University of California Press, Berkeley.
- VOIGT, S., M. BUCHWITZ, J. FISCHER, D. KRAUSE, AND R. GEORGI. 2009. Feather-like development of Triassic diapsid skin appendages. *Naturwissenschaften* 96:81–86.
- WAGNER, G. P. 2005. The developmental evolution of avian digit homology: An update. *Theory in Biosciences* 124:165–183.
- WAGNER, G. P., AND J. A. GAUTHIER. 1999. 1,2,3 = 2,3,4: A solution to the problem of the homology of the digits in the avian hand. *Proceedings of the National Academy of Sciences USA* 96:5111–5116.
- WALKER, A. D. 1961. Triassic reptiles from the Elgin area: *Stagonolepis*, *Dasygnathus* and their allies. *Philosophical Transactions of the Royal Society of London, Series B* 244:103–204.
- WALKER, A. D. 1964. Triassic reptiles from the Elgin area: *Ornithosuchus* and the origin of carnosaurs.

- Philosophical Transactions of the Royal Society of London, Series B 248:53–134.
- WALKER, A. D. 1970. A revision of the Jurassic reptile *Hallopus victor* (Marsh), with remarks on the classification of crocodiles. Philosophical Transactions of the Royal Society of London, Series B 257:323–372.
- WALKER, A. D. 1972. New light on the origin of birds and crocodiles. *Nature* 237:257–263.
- WALKER, A. D. 1977. Evolution of the pelvis in birds and dinosaurs. Pages 319–358 in *Problems in Vertebrate Evolution* (S. M. Andrews, R. S. Miles, and A. D. Walker, Eds.). Linnean Society, London.
- WALKER, A. D. 1980. The pelvis of *Archaeopteryx*. *Geological Magazine* 177:595–600.
- WALKER, A. D. 1985. The braincase of *Archaeopteryx*. Pages 123–134 in *The Beginnings of Birds: Proceedings of the International Archaeopteryx Conference Eichstatt 1984* (M. K. Hecht, J. H. Ostrom, G. Viohl, and P. Wellnhofer, Eds.). Freunde des Jura-Museums Eichstatt, Eichstatt.
- WALKER, A. D. 1990. A revision of *Sphenosuchus acutus* Haughton, a crocodylomorph reptile from the Elliot Formation (late Triassic or early Jurassic) of South Africa. Philosophical Transactions of the Royal Society of London, Series B 330:1–120.
- WANG, X., Z. ZHOU, F. ZHANG, AND X. XU. 2002. A nearly complete articulated rhamphorhynchoid pterosaur with exceptionally well-preserved wing membranes and “hairs” from Inner Mongolia, northeast China. *Chinese Science Bulletin* 47:226–232.
- WEISHAMPEL, D. B., P. DODSON, AND H. OSMÓLSKA, Eds. 2004. *The Dinosauria*, 2nd ed. University of California Press, Berkeley.
- WELLES, S. P. 1984. *Dilophosaurus wetherilli* (Dinosauria: Theropoda). Osteology and comparisons. *Palaeontographica A* 185:85–180.
- WELLES, S. P., AND R. A. LONG. 1974. The tarsus of theropod dinosaurs. *Annals of the South African Museum* 64:191–218.
- WELLNHOFER, P. 2004. The plumage of *Archaeopteryx*: Feathers of a dinosaur? Pages 282–300 in *Feathered Dragons: Studies on the Transition from Dinosaurs to Birds* (P. J. Currie, E. B. Koppelhus, M. A. Shugar, and J. L. Wright, Eds.). Indiana University Press, Bloomington.
- WELMAN, J. 1995. *Euparkeria* and the origin of birds. *South African Journal of Science* 91:533–537.
- WELTEN, M. C. M., F. J. VERBEEK, A. H. MEIJER, AND M. K. RICHARDSON. 2005. Gene expression and digit homology in the chicken embryo wing. *Evolution & Development* 7:18–28.
- WHETSTONE, K. N., AND L. D. MARTIN. 1979. New look at the origin of birds and crocodiles. *Nature* 279:234–236.
- WHETSTONE, K. N., AND P. J. WHYBROW. 1983. A “cursorial” crocodylian from the Triassic of Lesotho (Basutoland), southern Africa. University of Kansas Museum of Natural History, Occasional Papers no. 106.
- WIENS, J. J., P. T. CHIPPENDALE, AND D. M. HILLIS. 2003. When are phylogenetic analyses misled by convergence? A case study in Texas cave salamanders. *Systematic Biology* 52:501–514.
- WILKINSON, M. 1996. Majority-rule reduced consensus methods and their use in bootstrapping. *Molecular Biology and Evolution* 13:437–444.
- WILKINSON, M. 2003. Missing entries and multiple trees: Instability, relationships, and support in parsimony analysis. *Journal of Vertebrate Paleontology* 23:311–323.
- WILKINSON, M., AND J. L. THORLEY. 2001. No compromise on consensus. *Taxon* 50:181–184.
- WITMER, L. M. 1990. The craniofacial air sac system of Mesozoic birds (Aves). *Zoological Journal of the Linnean Society* 100:327–378.
- WITMER, L. M. 2002. The debate on avian ancestry: Phylogeny, function, and fossils. Pages 3–30 in *Mesozoic Birds: Above the Heads of Dinosaurs* (L. M. Chiappe and L. M. Witmer, Eds.). University of California Press, Berkeley.
- WU, X., AND S. CHATTERJEE. 1993. *Dibrothrosuchus elaphros*, a crocodylomorph from the Lower Jurassic of China and the phylogeny of the Sphenosuchia. *Journal of Vertebrate Paleontology* 13:58–89.
- XU, X. 2006. Feathered dinosaurs from China and the evolution of major avian characters. *Integrative Zoology* 1:4–11.
- XU, X., Y. CHENG, X. WANG, C. CHANG, AND H. CHANG. 2002a. An unusual oviraptorosaurian dinosaur from China. *Nature* 419:291–293.
- XU, X., J. M. CLARK, C. A. FORSTER, M. A. NORELL, G. M. ERICKSON, D. A. EBERTH, C. JIA, AND Q. ZHAO. 2006. A basal tyrannosauroid dinosaur from the Late Jurassic of China. *Nature* 439:715–718.
- XU, X., AND M. A. NORELL. 2004. A new troodontid dinosaur from China with avian-like sleeping posture. *Nature* 431:838–841.
- XU, X., M. A. NORELL, X. KUANG, X. WANG, Q. ZHAO, AND C. JIA. 2004. Basal tyrannosauroids from China and evidence for protofeathers in tyrannosauroids. *Nature* 431:680–684.
- XU, X., M. A. NORELL, X. WANG, P. J. MAKOVICKY, AND X. WU. 2002b. A basal troodontid from the Early Cretaceous of China. *Nature* 415:780–784.
- XU, X., Z. TANG, AND X. WANG. 1999a. A therizinosauroid dinosaur with integumentary structures from China. *Nature* 399:350–354.
- XU, X., X. WANG, AND X. WU. 1999b. A dromaeosaurid dinosaur with a filamentous integument from the Yixian Formation of China. *Nature* 401: 262–266.
- XU, X., AND X. WU. 2001. Cranial morphology of *Sinornithosaurus millenii* Xu et al. 1999 (Dinosauria: Theropoda: Dromaeosauridae) from the Yixian Formation of Liaoning, China. *Canadian Journal of Earth Sciences* 38:1739–1752.
- XU, X., Z. ZHOU, AND X. WANG. 2000. The smallest known non-avian theropod dinosaur. *Nature* 408:705–708.

- XU, X., Z. ZHOU, X. WANG, X. KUANG, F. ZHANG, AND X. DU. 2003. Four-winged dinosaurs from China. *Nature* 421:335–340.
- XU, X., Z. ZHOU, X. WANG, X. KUANG, F. ZHANG, AND X. DU. 2005. Origin of flight—Could “four-winged” dinosaurs fly? (Reply). *Nature* 438:E3–E4.
- YATES, A. M., AND C. C. VASCONCELOS. 2005. Furcula-like clavicles in the prosauropod dinosaur *Masospondylus*. *Journal of Vertebrate Paleontology* 25:466–468.
- YOU, H., M. C. LAMANNA, J. D. HARRIS, L. M. CHIAPPE, J. O’CONNOR, S. JI, J. LÜ, C. YUAN, D. LI, X. ZHANG, AND OTHERS. 2006. A nearly modern amphibious bird from the Early Cretaceous of northwestern China. *Science* 312:1640–1643.
- ZANNO, L. E. 2006. The pectoral girdle and forelimb of the primitive therizinosauroid *Falcarius utahensis* (Theropoda, Maniraptora): Analyzing evolutionary trends within Therizinosauroidea. *Journal of Vertebrate Paleontology* 26:636–650.
- ZHANG, F., AND Z. ZHOU. 2000. A primitive enantiornithine bird and the origin of feathers. *Science* 290:1955–1959.
- ZHANG, F., Z. ZHOU, X. XU, X. WANG, AND C. SULLIVAN. 2008. A bizarre Jurassic maniraptoran from China with elongate ribbon-like feathers. *Nature* 455:1105–1108.
- ZHENG, X., Z. ZHANG, AND L. HOU. 2007. A new enantiornithine bird with four long rectrices from the Early Cretaceous of northern Hebei, China. *Acta Geologica Sinica* 81:703–708.
- ZHOU, H., AND L. NISWANDER. 1996. Requirement for BMP signaling in interdigital apoptosis and scale formation. *Science* 272:738–741.
- ZHOU, Z. 2004. The origin and early evolution of birds: Discoveries, disputes, and perspectives from fossil evidence. *Naturwissenschaften* 91:455–471.
- ZHOU, Z., AND L. HOU. 2002. The discovery and study of Mesozoic birds in China. Pages 160–183 in *Mesozoic Birds: Above the Heads of Dinosaurs* (L. M. Chiappe and L. M. Witmer, Eds.). University of California Press, Berkeley.
- ZHOU, Z., AND L. MARTIN. 1999. Feathered dinosaur or bird? A new look at the hand of *Archaeopteryx*. *Smithsonian Contributions to Paleobiology* 89:289–293.
- ZHOU, Z., X. WANG, F. ZHANG, AND X. XU. 2000. Important features of *Caudipteryx*—Evidence from two nearly complete new specimens. *Vertebrata Palasiatica* 38:241–254.
- ZHOU, Z., AND F. ZHANG. 2001. Two new ornithurine birds from the Early Cretaceous of western Liaoning, China. *Chinese Science Bulletin* 46:1258–1264.
- ZHOU, Z., AND F. ZHANG. 2002. A long-tailed, seed-eating bird from the Early Cretaceous of China. *Nature* 418:405–409.
- ZHOU, Z., AND F. ZHANG. 2003a. Anatomy of the primitive bird *Sapeornis chaoyangensis* from the Early Cretaceous of Liaoning, China. *Canadian Journal of Earth Sciences* 40:731–747.
- ZHOU, Z., AND F. ZHANG. 2003b. *Jeholornis* compared to *Archaeopteryx*, with a new understanding of the earliest avian evolution. *Naturwissenschaften* 90:220–225.
- ZHOU, Z., AND F. ZHANG. 2005. Discovery of an ornithurine bird and its implication for Early Cretaceous avian radiation. *Proceedings of the National Academy of Sciences USA* 102:18998–19002.

APPENDIX 1: SPECIMENS EXAMINED

Institution	Specimen	Specimen number
UKMNH	<i>Archaeopteryx</i>	KU25350, cast of JM 2257
UKMNH	<i>Archaeopteryx</i>	Cast of BMNH 37001
UKMNH	<i>Archaeopteryx</i>	Cast of HMN 1880
UKMNH	<i>Bambiraptor</i>	AMNH 001 (AMNH FR: 30556)
UKMNH	<i>Bambiraptor</i>	KUVP 129737
UKMNH	<i>Confuciusornis</i>	Cast of IVPP V 11552
UKMNH	<i>Confuciusornis</i>	Cast of IVPP V 51556
UKMNH	<i>Patagopteryx</i>	Cast of MACN-N-11
UKMNH	<i>Sinornis (Cathayornis)</i>	Epoxy cast of BPV 538a
UKMNH	<i>Sinornis (Cathayornis)</i>	Epoxy cast of BPV 538b
UKMNH	<i>Sinornis (Cathayornis)</i>	Epoxy cast of IVPP V 9769A
UKMNH	<i>Unenlagia</i>	Cast of MCH PVP 78
RTMP	<i>Sauromitholestes</i>	RTMP 88.121.39
RTMP	<i>Struthiomimus</i>	TMP 90.26.01
RTMP	<i>Troodon</i>	TMP 82.19.23
RTMP	<i>Troodon</i>	RTMP 86.36.457

Abbreviations: UKMNH = University of Kansas Museum of Natural History, RTMP = Royal Tyrrell Museum of Paleontology.

APPENDIX 2: CHARACTER LIST FOR 242
CHARACTERS, NOTES, AND REFERENCES

Except for the characters that have ordered states, character states are not polarized; that is, zero does not necessarily represent the plesiomorphic state. “?” indicates missing data for a taxon; “–” indicates a character state that was not applicable for a taxon (e.g., dental characters for *Citipati*). Characters that are common to most analyses or that, to our knowledge, are unique to the present analysis are not followed by source citations. Characters that are not common to most analyses or that were taken from a specific study are followed by citations of the sources from which they were taken. If we altered the wording or structure of a character, we noted that the character was modified when citing its source. Twenty-one characters of the carpus, manus, palate, and basipterygoid; some characters of the palate; and some characters of the tarsus were included but only turned on in the alternative analysis of the data matrix. These 21 characters are listed at the end (characters 222–242).

Integument

1. Elongate integumentary structures wider at tip than base, with follicle and tubular shaft or calamus: absent (0); present (1).
2. Vaned integumentary structures: symmetric (0); asymmetric (1). Clark et al. (2002).

3. Alula: absent (0); present (1). Chiappe (2002a).
4. Vaned integumentary structures on hind limb: not present or poorly developed (0); well developed, extensive (1).
5. Dorsal body osteoderms: absent (0); present (1). Benton (1999).

Cranium

6. Premaxilla, posterior process: short and blunt (0); elongate and extending along nasal-maxillary suture posterior to external nares (1). Clark et al. (2002).
7. Premaxillae: unfused (0); fused (1). Lü et al. (2002).
8. Premaxilla: maxillary process contacts nasal to form posterior border of nares (0); maxillary process reduced so that maxilla participates broadly in external naris (1). Modified from Clark et al. (2002).
9. Premaxilla: crenulate margin on buccal edge absent (0); present (1). Clark et al. (2002).
10. Internarial bar: rounded (0); flat (1). Clark et al. (2002).
11. Maxilla, reduced in lateral aspect: absent (0); present (1). Martin and Czerkas (2000).
12. External naris: short with posterior margin not reaching anterior border of antorbital fossa (0); elongate with posterior margin reaching or overlapping anterior border of the antorbital fossa (1); elongate, tall, nearly vertical (2). Modified from Clark et al. (2002).

13. Interfenestral bar: not present (0); present (1). Makovicky et al. (2003).
14. Antorbital fenestra: present and without any significant antorbital fossa (0); antorbital fenestra and fossa well developed (1); antorbital fenestra and fossa absent (2). Modified from Benton (2004).
15. Antorbital fossa, pronounced accessory fenestra: absent (0); present (1). Modified from Clark et al. (2002).
16. Antorbital fossa, tertiary fenestra: absent (0); present (1). Modified from Clark et al. (2002).
17. Narial region pneumaticity: apneumatic or poorly pneumatized (0); extensively pneumatized (1). Modified from Clark et al. (2002).
18. Orbit, shape: round in lateral or dorsolateral view (0); dorsoventrally elongate (1); anteroposteriorly elongate (2). Modified from Clark et al. (2002).
19. Orbit, size: not significantly enlarged relative to the rest of the skull, frontals not arched (0); clearly inflated, frontals strongly arched (1).
20. Prefrontal: not expanded within orbit (0); expanded within orbit, meeting interorbital septum (1); absent (2). Modified from Walker (1990) and Benton (1999).
21. Prefrontal, size: broad dorsal exposure similar to that of lacrimal (0); greatly reduced in size (1). Modified from Clark et al. (2002).
22. Lacrimal: caudal process absent or small (inverted "L-shape") (0); present and lacrimal "T-shaped" in lateral view (1); curved, opening caudally (reversed "C-shape") (2). Modified from Clark et al. (2002) and Lü et al. (2002).
23. Lacrimal: supraorbital crests absent in adult (0); crest(s) or lateral expansions dorsal and/or anterolateral to orbit (1). Modified from Clark et al. (2002).
24. Lacrimal: no enlarged foramen or foramina opening laterally at the angle of the lacrimal (0); enlarged foramen or foramina opening laterally at the angle of the lacrimal (1). Clark et al. (2002).
25. Postfrontal: present (0); absent (1). Benton (1999).
26. Postorbital: present (0); absent (1).
27. Postorbital, lateral view: straight anterior (frontal) process (0); frontal process curves anterodorsally, and dorsal border of temporal bar is dorsally concave (1). Clark et al. (2002).
28. Postorbital bar: jugal and postorbital contributing equally to postorbital bar (0); ascending process of jugal reduced and descending process of postorbital ventrally elongate (1); absent (2). Ordered. Modified from Clark et al. (2002).
29. Postorbital bar: parallels quadrate, lower temporal fenestra rectangular in shape (0); jugal and postorbital approach or contact quadratojugal to constrict lower temporal fenestra (1). Clark et al. (2002).
30. Postorbital/squamosal temporal bar anteroposteriorly short, with subtriangular laterotemporal fenestra: absent (0); present (1); no distinct laterotemporal fenestra present (2). Sereno (1991).
31. Jugal bar: large (0); thin, reduced in height, strap like or rod like (1). Modified from Lü et al. (2002).
32. Quadratojugal: without a horizontal process caudal to the ascending process (reversed "L" or "L-shape") (0); or with process (i.e., inverted "T" or "Y-shape") (1); greatly reduced (2); fused to the jugal and not distinguishable (3). Ordered. Modified from Clark et al. (2002).
33. Quadratojugal or quadratojugal/jugal: sutured to quadrate (0); ligamentous (1). Modified from Ruben and Jones (2000).
34. Quadrate: without lateral, round cotyla on the mandibular process (0); with cotyla (1). Modified from Chiappe (2002a).
35. Quadrate, orbital process: absent (0); small or broad, not distinct and pointed (1); distinct and pointed (2). Modified from Chiappe (2002a).
36. Quadrate, lateral border: straight or without enlarged quadrate foramen ("paraquadratic foramen") (0); with lateral tab that touches squamosal and quadratojugal above an enlarged quadrate foramen ("paraquadratic foramen") (1). Clark et al. (2002).
37. Quadrate: apneumatic (0); pneumatic (1). Witmer (1990).
38. Quadrate, articulation: singular with squamosal or squamosal and opisthotic (0); bipartite with dermal and endochondral bones, anteriorly with prootic, squamosal, and laterosphenoid and posteriorly with prootic and the fused opisthotic and exoccipital (1). Modified from Walker (1972) and Martin (1983).

39. Quadrate, head: single (0); double (1). Walker (1972) and Martin (1983).
40. Quadrate: vertical (0); strongly inclined posteroventrally so that the distal end lies far forward of the proximal end (1); strongly inclined anteriorly so that the proximal end lies far forward of the distal end (2). Modified from Walker (1972) and Clark et al. (2002).
41. Quadrate, distal end: one or two transversely aligned condyles (0); triangular condylar pattern, usually composed of three condyles (1). Modified from Chiappe (2002a).
42. Squamosal: with descending process contacting quadratojugal (0); with descending process not contacting quadratojugal (1); without descending process (2). Modified from Clark et al. (2002).
43. Squamosal, descending process: parallels quadrate shaft (0); nearly perpendicular to quadrate shaft (1). Clark et al. (2002).
44. Squamosal: distinct and separate element (0); incorporated into braincase (1). Modified from Chiappe (2002a).
45. Frontals: separate (0); fused (1). Holtz (2000).
46. Frontals: narrow anteriorly as a wedge between nasals (0); end abruptly anteriorly, suture with nasal transversely oriented (1). Clark et al. (2002).
47. Frontals: anterior emargination of supratemporal fossa straight or slightly curved (0); strongly sinusoidal and reaching onto postorbital process (1). Currie (1995) and Clark et al. (2002).
48. Frontals, postorbital process in dorsal view: smooth transition from orbital margin (0); sharply demarcated from orbital margin (1). Currie (1995) and Clark et al. (2002).
49. Frontal: edge smooth in region of lacrimal suture (0); edge notched (1). Currie (1995) and Clark et al. (2002).
50. Parietals: separate (0); fused (1). Clark et al. (2002).
51. Skull, roof: not strongly convex (0); strongly convex (1).
- Palate
52. Vomers: not fused (0); fused anteriorly (1). Gauthier (1986).
53. Palatal teeth: present (0); absent (1). Benton (1999).
54. "Secondary palate": no distinct "secondary palate" (0); "secondary palate" short (1); "secondary palate" extensive (2).
55. Maxilla, palatal shelf: flat (0); with midline ventral tooth-like projection (1). Clark et al. (2002).
56. Posterior maxillary sinus cup shaped: absent (0); present (1). Modified from Chiappe (2002a).
57. Ectopterygoid: present with no jugal "hook" (0); attached to jugal by a distinctly "hook-like" process (1); present but not attached to jugal (2); absent (3). Modified from Elzanowski (1999).
58. Ectopterygoid, position: ventral to or level with transverse flange of pterygoid (0); dorsal to transverse flange of pterygoid (1). Modified from Sereno and Novas (1993).
59. Ectopterygoid: no fossa on ventral surface (0); fossa on ventral surface (1). Modified from Clark et al. (2002).
60. Ectopterygoid: no fossa on dorsal surface (0); fossa on dorsal surface (1). Clark et al. (2002).
- Braincase and otic region
61. Occipital condyle: larger than or equal to foramen magnum in size (0); smaller than foramen magnum (1).
62. Post-temporal fenestra: large (0); reduced to a foramen or slit, or absent (1). Modified from Sereno and Novas (1993).
63. Foramina for entrance of cerebral branches of internal carotid arteries into braincase: positioned on the posteroventral surface of the parabasisphenoid (0); positioned on the lateral surface or anterolateral surface of the parabasisphenoid (1). Gower (2002).
64. Basisphenoidal recess: present (0); shallow or absent (1). Currie and Zhao (1993b).
65. Parabasisphenoid, "semilunar depression": present (0); absent (1). Gower and Weber (1998).
66. Cultriform process of parabasisphenoid: base not highly pneumatized or pneumatized but without an inflated bulla (0); highly pneumatized with base expanded and pneumatic, forming a parasphenoid bulla (1). Modified from Clark et al. (2002).
67. Paroccipital process: straight, projects laterally or posterolaterally (0); distal end curves ventrally, pendant (1). Clark et al. (2002).
68. Paroccipital process: straight distal end (0); distal end twisted to face posterodorsally (1). Currie (1995).
69. Eustachian tubes: not enclosed by bone (0); partially or fully enclosed (1). Gower and Weber (1998) and Gower (2002).

70. Vestibule, ossification of medial wall: incomplete (0); almost or completely ossified (1). Gower and Weber (1998) and Gower (2002).
71. Metotic fissure: persisting as an undivided opening (i.e., the metotic foramen) (0); subdivided during development with a foramen for the vagus (X) nerve and jugal vein ("vagal" or "jugular foramen") separated via an osseous, "prevagal commissure" from the lateral aperture (= fenestra pseudorotunda) of a recessus scalae tympani (1). Whetstone and Martin (1979), Rieppel (1985), Gower and Weber (1998).¹
72. Perilymphatic foramen, position: medial and oriented so as to transmit the perilymphatic duct out of the otic capsule in a posteromedial or posterior direction (0); foramen positioned more laterally so that the perilymphatic duct is transmitted posterolaterally or laterally and the foramen is at least partly visible in lateral view (1). Gower and Weber (1998), Gower (2002).
73. Cochlear recess: not clearly differentiated or short (0); clearly differentiated and elongate (1). Walker (1990), Gower and Weber (1998), Gower (2002).
74. Hypoglossal (XII) nerve has three or more external foramina in posterolateral region of braincase floor: absent (0); present (1). Currie and Zhao (1993b).
75. Vagus (X) nerve diverted, exiting on the occiput: absent (0); present (1). Currie and Zhao (1993b).
76. Posterior tympanic recess: absent (0); opens on anterior margin of paroccipital process (1); opens within columellar recess (2). Ordered. Modified from Clark et al. (2002).
77. Dorsal tympanic recess: absent (0); present (1). Witmer (1990).
78. Anterior tympanic recess: absent (0); present (1). Witmer (1990).
79. Contralateral communication between at least some tympanic diverticulae: absent (0); present (1).
- Dentition²
80. Premaxilla: toothed (0); toothless (1).
81. Maxilla: toothed (0); toothless (1).
82. Dentary: toothed (0); toothless (1).
83. Premaxillary teeth: serrated (0); some without serrations anteriorly (1); some or all teeth without serrations (2). Modified from Clark et al. (2002).
84. Premaxillary tooth crowns: in cross section crowns suboval to subcircular (0); asymmetrical (D-shaped in cross section) with flat lingual surface (1). Clark et al. (2002).
85. Maxillary teeth: serrated (0); some without serrations anteriorly (1); some or all teeth without serrations (2). Modified from Clark et al. (2002).
86. Dentary teeth: serrated (0); some without serrations anteriorly (1); some or all teeth without serrations (2). Modified from Clark et al. (2002).
87. Dentary and maxillary teeth: less than 25 in dentary (0); 25–30 in dentary (1); teeth relatively small, and numerous (more than 30 in dentary) (2). Modified from Clark et al. (2002).
88. Dentary teeth, spacing: even (0); anterior dentary teeth smaller, more numerous, and more closely appressed than those in middle of tooth row (1). Clark et al. (2002).
89. Dentary tooth implantation: in individual sockets (0); some teeth in communal groove beginning posteriorly (1); all teeth in a communal groove (2). Ordered. Modified from Chiappe (2002a).
90. Serration denticles: not apically hooked (0); apically hooked (1). Modified from Clark et al. (2002) and from Makovicky and Norell (2004).
91. Teeth with expanded roots: absent (0); present in at least some teeth (1); present in all teeth (2). Martin et al. (1980) and Martin and Stewart (1999).
92. Premaxillary teeth with constriction between crown and root: absent (0); present (1). Martin et al. (1980) and Martin and Stewart (1999).
93. Maxillary teeth with constriction between crown and root: absent (0); present (1). Martin et al. (1980) and Martin and Stewart (1999).
94. Dentary teeth with constriction between crown and root: absent (0); present (1). Martin et al. (1980) and Martin and Stewart (1999).
95. Oval resorption pit on lingual aspect of root surrounding developing crown and closed at bottom: absent (0); present (1). Martin et al. (1980) and Martin and Stewart (1999).
- Mandible
96. Interdental plates: present (0); absent (1). Martin et al. (1980) and Martin and Stewart (1999).

97. Mandibular symphysis: not ossified or only loosely sutured (0); tightly sutured (1); fused (2). Ordered. Modified from Maryańska et al. (2002).
98. Dentary: symphyseal region broad and straight paralleling lateral margin (0); medially recurved slightly (1); strongly recurved medially (2). Clark et al. (2002).
99. Dentary: symphyseal region in line with main part of buccal edge (0); symphyseal edge downturned (1). Clark et al. (2002).
100. Dentary, posterior end: without posterodorsal process dorsal to mandibular fenestra or with only a small posterodorsal process over anterior part of the external mandibular fenestra (0); well-developed posterodorsal process extending over most of the external mandibular fenestra (1). Modified from Clark et al. (2002).
101. Dentary, labial face: flat (0); with lateral ridge and inset tooth row (1). Clark et al. (2002).
102. Dentary, nutrient foramina on external surface: superficial (0); lying in a deep groove (1). Clark et al. (2002).
103. Intramandibular joint: absent or poorly developed (0); present and well developed (1). Gauthier (1986) and Benton (1999).
104. External mandibular fenestra: present (0), absent (1).
105. External mandibular fenestra: not subdivided by a spinous anterior process of the surangular (0); subdivided by a spinous anterior process of the surangular (1). Clark et al. (2002).
106. Surangular, lateral surface: no foramen for process of dentary (0); foramen in lateral surface for process of dentary (1). Modified from Clark et al. (2002).
107. Surangular, lateral surface: no horizontal shelf (0); prominent, laterally expanding horizontal shelf present anteroventral to the mandibular condyle (1). Holtz (2004).
108. Splenial: not widely exposed on lateral surface of mandible (0); exposed as a broad triangle between dentary and angular on lateral surface of mandible (1). Clark et al. (2002).
109. Coronoid ossification: present (0); vestigial or absent (1). Elzanowski (1999).
110. Articular and surangular coossified: absent (0); present (1). Elzanowski (1999).
111. Articular, surface for quadrate: with neither lateral nor medial processes (0); with development of either a lateral process or a medial process or both (1). Modified from Elzanowski (1999).
112. Articular pneumaticity: absent (0); present (1). Witmer (1990).
113. Retroarticular process: absent (0); short, stout (1); elongate and slender (2); elongate and slender, with vertical columnar process rising from posteromedial corner (3). Modified from Currie (1995) and from Clark et al. (2002).
- Axial skeleton
114. Cervicodorsal hypapophyses: absent (0); present (1).
115. Axial and postaxial epiphyses: absent or poorly developed, not extending past posterior rim of postzygapophyses (0); large, posteriorly directed, extended beyond postzygapophyses (1). Modified from Clark et al. (2002).
116. Axial neural spine: flared transversely (0); compressed mediolaterally (1). Clark et al. (2002).
117. Axial neural spine: does not extend anteriorly beyond prezygapophyses (0); extends anteriorly beyond prezygapophyses (1). Tykoski and Rowe (2004).
118. Postaxial intercentra: present (0); absent (1). Sereno (1991).
119. Anterior cervical centra: subcircular or square in anterior view (0); distinctly wider than high, kidney-shaped (1). Clark et al. (2002).
120. Posterior cervical vertebrae: no carotid processes (0); carotid processes present (1). Clark et al. (2002).
121. Cervical vertebrae, neural spines: anteroposteriorly long (0); short and centered on neural arch (1). Clark et al. (2002).
122. Cervical and anterior trunk vertebrae: procoelus (0); amphicoelus (1); opisthocoelus (2); incipiently heterocoelus (3); fully heterocoelus (4); platycoelus (5); anterior articular surface flat, posterior surface weakly concave (6). Modified from Clark et al. (2002).
123. Dorsal vertebrae, hyposphene-hypantrum accessory intervertebral articulations: absent (0); present (1). Gauthier (1986).
124. Dorsal vertebrae, transverse processes: straight or slightly backswept (0); strongly posteriorly backswept, triangular in dorsal view (1). Tykoski and Rowe (2004).
125. Dorsal vertebrae: zygapophyses abut one another above neural canal, opposite hyposphenes meet to form lamina (0);

- zygapophyses placed lateral to neural canal and separated by groove for interspinous ligaments, hyosphenes separated (1). Clark et al. (2002).
126. Caudal dorsal vertebrae, parapophyses: flush with neural arch (0); distinctly projected on pedicels ("stalked") (1). Modified from Clark et al. (2002).
127. Dorsal centra, pleurocoels: absent (0); present on some centra (1); present on all centra (2). Ordered. Modified from Clark et al. (2002).
128. Dorsal vertebrae neural spines: scars for interspinous ligaments terminate at apex of neural spine (0); terminate below apex of neural spine (1). Clark et al. (2002).
129. Presacral vertebrae: apneumatic (0); cervicals or dorsals pneumatic (1); all presacral vertebrae pneumatic (2). Modified from Clark et al. (2002).
130. Sacral vertebrae, number: two (0); three–four (1); five (2); six (3); seven or more (4). Benton (1999) and Clark et al. (2002).
131. Synsacrum: absent in adults (0); present in adults (1). Holtz (2000).
132. Caudal vertebrae: 40 or more (0); 39–25 (1); fewer than 25 (2). Ordered. Modified from Clark et al. (2002).
133. Caudal vertebrae: caudals homogenous in shape, without transition point (0); distinct transition point in caudal series, from shorter centra with long transverse processes proximally to longer centra with small or no transverse processes distally (1). Modified from Clark et al. (2002).
134. Caudal vertebrae: transition point in caudal series begins distal to the 10th caudal (0); at or proximal to the 10th caudal (1). Clark et al. (2002).
135. Caudal vertebrae: zygapophyses not elongate (0); elongate, extending past centrum to contact other centra (1); extremely elongate, ossified tendons well developed (2). Ordered. Ostrom (1969) and Clark et al. (2002).
136. Pygostyle: absent (0); present (1). Modified from Chiappe (2002a).
137. Cervical ribs: shafts slender and each longer than vertebra to which it articulates (0); broad and shorter than vertebra (1); fused (2). Clark et al. (2002).
138. Gastralia: present (0); absent (1).
139. Uncinate processes: absent or cartilaginous (0); ossified (1). Modified from Clark et al. (2002).
140. Sternal ribs: absent or cartilaginous (0); ossified (1). Modified from Clark et al. (2002).
141. Sternum: absent or cartilaginous (0); ossified plates separate in adult (1); ossified plates fused in adult (2). Ordered. Modified from Clark et al. (2002).
142. Sternum, keel: absent or weakly developed (0); present and limited to posterior margin of sternum (1); extends to anterior margin of sternum (2). Ordered. Modified from Chiappe (2002a).
143. Sternum, costal facets: absent (0); present (1). Chiappe (2002a).
144. Sternum, lateral processes: absent (0); present (1). Modified from Clark et al. (2002) and Chiappe (2002a).
145. Sternum, anterior margin grooved for reception of coracoids: absent (0); present (1). Clark et al. (2002).
146. Sternum, articular facets for coracoid: lateral or anterolateral (0); almost or fully anterior (1). Modified from Clark et al. (2002).
- Appendicular skeleton (pectoral girdle and forelimb)
147. Interclavicle: present (0); rudimentary or absent (1); incorporated into sternum (2); incorporated into furcula (3). Modified from Benton (1999) and Martin et al. (1998a).³
148. Clavicles: present (0); rudimentary or absent (1); fused into furcula (2). Modified from Benton (1999).⁴
149. Furcula, shape: broad "V-shaped" (0); boomerang shaped (1); narrow "V-shaped" (2); "U-shaped" (3). Modified from Chiappe (2002a).
150. Furcula, hypocleidium: absent (0); small (1); prominent, long (2). Clark et al. (2002).
151. Scapula, acromion process: absent (0) weakly developed (1); quadrangular (2); columnar or triangular, projecting cranially away from corpus of scapula and glenoid fossa, but not laterally everted in dorsal view (3); projecting cranially away from corpus of scapula and glenoid fossa and laterally everted in dorsal view (4).
152. Scapula, shape: not elongate and strap-like (0), elongate and strap-like (1). Martin (2004).
153. Scapula, shaft: straight (0); sagittally curved (1). Chiappe (2002a).
154. Scapula, position: not parallel to the vertebral column (0); parallel to the vertebral column (1). Martin (2004).

155. Scapula and coracoid: articulate through a wide suture or fused (0); meeting at a mobile joint (1). Modified from Clark et al. (2002).
156. Scapula and coracoid: angle formed between scapula and coracoid obtuse (0); coracoid reflected, forming right angle to the scapula (1); coracoid reflected at an acute angle to the scapula (2). Ordered.
157. Coracoid: short (0), elongated with trapezoidal profile (1); strut-like (2). Ordered. Chiappe (2002a).
158. Coracoid: no proximal constriction to form "neck" (0); proximally constricted (1). Modified from Senter et al. (2004).
159. Coracoid in lateral view: not distinctly triangular (0); distinctly triangular (1).
160. Coracoid, acroracoid process: not present or poorly developed (0), present (1). Modified from Chiappe (2002a).
161. Coracoid, procoracoid process: not present or poorly developed (0); present (1). Chiappe (2002a).
162. Coracoid, lateral margin: not distinctly convex (0); distinctly convex (1). Chiappe and Walker (2002).
163. Coracoid, supracoracoid nerve foramen: superficial (0); opens into an elongate furrow medially, separated from medial margin of the coracoid by a thick, bony bar (1). Chiappe and Walker (2002).
164. Triosseal canal: not present (0); present (1).
165. Glenoid fossa: lateral (0); posteroventral (1); dorsolateral (2). Martin (1983, 2004).
166. Proximal humerus: medial margin of humerus under the inner trochanter nearly straight, not strongly arched (0); medial margin of humerus strongly arched under a prominent internal tuberosity, often approaching horizontal inclination (1). Sereno (1991).
167. Humerus: no distinct transverse ligamental groove (0); distinct transverse ligamental groove present (1).
168. Humerus, bicipital crest: absent or rudimentary (0); present (1). Modified from Chiappe (2002a).
169. Humerus, deltopectoral crest: distinct, quadrangular, or triangular (0); less pronounced, forming an arc rather being quadrangular (1); proximal humerus with rounded edges and poorly developed deltopectoral crest (2). Modified from Clark et al. (2002).
170. Humerus, distal condyles: symmetrical, approximately equal in size and height (0); somewhat asymmetrical, with the radial condyle noticeably larger and taller than the ulnar condyle (1); strongly asymmetrical with the radial condyle much larger and taller than the ulnar condyle (2). Paul (2002) and Gishlick (2001).
171. Humerus: without well-developed brachial depression on anterior face of distal humerus (0); well-developed brachial depression present (1). Chiappe (2002a).
172. Humerus: without well-developed olecranon fossa on posterior face of distal end of humerus (0); well-developed olecranon fossa present (1). Chiappe (2002a).
173. Ulna, proximal articular surface: single continuous articular facet (0); divided into at least two distinct fossae separated by a median ridge (1). Clark et al. (2002).
174. Ulna: olecranon process weakly developed (0); distinct and large (1). Clark et al. (2002).
175. Ulna, distal articular surface: flat (0); slightly convex (1); strongly convex (2). Ordered. Modified from Clark et al. (2002).
176. Ulna, distal surface: labrum condyli not well developed (0); well developed (1). Modified from Chiappe (2002a).
- Appendicular skeleton (pelvic girdle and hind limb)
177. Ilium, anterior process: ventral edge straight or gently curved (0); ventral edge hooked anteriorly (1); very strongly hooked (2). Modified from Clark et al. (2002).
178. Ilium, preacetabular process: shorter than or nearly equal to postacetabular process of ilium (0); preacetabular process of ilium expanded, longer than postacetabular process of ilium (1).
179. Ilium, postacetabular process, lateral view: squared (0); somewhat convex (1); acuminate (2). Ordered. Modified from Clark et al. (2002).
180. Ilium, brevis fossa: absent (0); shelflike (1); deeply concave with lateral overhang (2). Modified from Clark et al. (2002).
181. Ilium, "cuppedicus" fossa: absent or poorly developed (0); present and formed as an antiliac shelf anterior to the acetabulum, extending posteriorly to above anterior end of the acetabulum (1); posterior end of fossa on anterior end of pubic peduncle, anterior to acetabulum (2). Modified from Clark et al. (2002).
182. Ilium, "cuppedicus" fossa: deep fossa ventrally concave (0); shallow or slightly

- concave, no lateral overhang (1). Modified from Clark et al. (2002).
183. Ilium, antitrochanter: absent (0); weakly developed (1); prominent (2). Ordered.
 184. Ilium: supracetabular crest present (0); supracetabular crest absent (1). Naples et al. (2002).
 185. Acetabulum: imperforate (0); semiperforate (1); fully perforate (2). Ordered. Benton (1999).
 186. Pubes: vertical (0); propubic (1); opisthopubic (2). Naples et al. (2002).
 187. Pubes: shorter than or nearly equal in length to ischia (0); longer than ischia (1). Sereno (1991).
 188. Pubes: fused in distal symphysis (0); pubic bones separate (1).
 189. Pubes: pubic shaft straight (0); distal end curves anteriorly, anterior surface of shaft concave (1). Clark et al. (2002).
 190. Pubes: no strong posterior "kink" in pubes (0); strong posterior "kink" at midshaft (1). Modified from Senter et al. (2004).
 191. Calceus pubis: absent (0); present and with anterior and posterior projections (1); with little or no anterior projection (2). Modified from Clark et al. (2002).
 192. Ischium, proximodorsal process approaching or abutting the ventral margin of the ilium: absent (0); present (1). Chiappe (2002a).
 193. Ischium, obturator process: absent (0); present and proximal in position (1); located near middle of ischiadic shaft (2); located at distal end of ischium (3). Modified from Clark et al. (2002).
 194. Ischium, obturator process: does not contact pubis (0); contacts pubis (1); forms a broad pubioischiadic plate (2). Clark et al. (2002).
 195. Ischium, obturator notch or foramen: present (0); absent (1). Modified from Clark et al. (2002).
 196. Ischium: ischial boot (expanded distal end) absent (0); present (1). Modified from Clark et al. (2002).
 197. Femur: proximal articular surface not extended under femoral head (0); extended under femoral head (1). Sereno and Arcucci (1994).
 198. Femoral head, orientation: oblique (0); at right angle to shaft (1).
 199. Femoral neck: absent (0); present (1). Chiappe (2002a).
 200. Femur: lesser trochanter separated from greater trochanter by deep cleft (0); trochanters separated by a small groove (1); trochanters completely fused to form crista trochanteris (2); greater and lesser trochanters not well developed (3). Modified from Clark et al. (2002).
 201. Femur, lesser trochanter: absent or not well developed (0); distinct but small, not elongate (1); alariform (2); cylindrical in cross section (3). Modified from Clark et al. (2002).
 202. Femur: posterior trochanter absent or represented by rugose area (0); distinctly raised from shaft and moundlike (1); forming a distinct ridge (2). Some confusion surrounds the meaning of the term "posterior trochanter." Here, the interpretation of Ostrom (1969) is followed rather than that of Gauthier (1986). Clark et al. (2002).
 203. Femur, fourth trochanter: present (0); indistinct or absent (1). Clark et al. (2002).
 204. Femur, anterior surface: no crest proximal to medial distal condyle (0); crest proximal to medial distal condyle extending onto anterior surface of shaft (1). Clark et al. (2002).
 205. Fibula: reaches the proximal tarsals (0); reduced distally and not meeting the proximal tarsals (1).
 206. Fibula, anterior trochanter: developed as a low vertical crest or oval rugosity, or trochanter absent (0); robust, knob-shaped, giving fibula a crooked profile in lateral or medial view (1). Modified from Sereno (1991).
 207. Tibia, medial cnemial crest: absent (0); present (1). Modified from Clark et al. (2002).
 208. Tibia, calcaneum, and astragalus: unfused (0); partly fused (1); completely fused, forming a tibiotarsus (2). Ordered. Modified from Chiappe (2002a).
 209. Supratendinal bridge: absent (0); present (1). Chiappe (2002a).
 210. Astragalus, tibial articular surface flexed: absent (0); present (1). Sereno (1991).
 211. Calcaneal facets for fibula and distal tarsal four: separated (0); contiguous (1). Sereno (1991).
 212. Calcaneal condyle hemicylindrical: absent (0); present (1). Benton (1999).
 213. Proximal tarsals and distal tarsals: meeting in a hinge, forming simple mesotarsal ankle (0); not forming a mesotarsal ankle (1).

214. Distal tarsals: free (0); partially fused to metatarsals (1); completely fused to metatarsals (2); fused and forming a "tarsal cap" (3). Martin (1983, 1991, 2004).
215. Hypotarsus: not present (0); present (1). Chiappe (2002a).
216. Metatarsals: unfused (0); proximodistal fusion forming tarsometatarsus (1); distoproximal fusion forming tarsometatarsus (2). Martin (1991).
217. Metatarsus configuration: metatarsals diverging from ankle (0); compact with metatarsals I–IV tightly bunched (1). Modified from Benton (1999).
218. Metatarsal III: visible between metatarsals II and IV (0); pinched between metatarsals II and IV, the latter two contacting one another proximally in front of III (1); not reaching proximal end of metatarsus (2). Ordered. Modified from Clark et al. (2002).
219. Metatarsal V: present with "hooked" proximal end (0); present without "hooked" proximal end (1); reduced to a splint (2); absent (3). Ordered.
220. Second pedal digit with hypertrophied claw: absent (0); present (1).
221. Hallux: not reversed (0); partially reversed (1); completely reversed (2); hallux absent (3). Ordered. Modified from Chiappe (2002a).
- Characters Turned On for Alternative Analysis
222. Basipterygoid process: well developed (0); abbreviated (1); absent (2).
223. Palatine: without elongate maxillary process (0); with elongate maxillary process (1).
224. Palatine: without "hook-shaped" process enclosing choana (0); with process (1).
225. Palatine: without broad pterygoid wing (0); with broad pterygoid wing (1).
226. Palatine: tetra radiate with jugal process (0); triradiate without jugal process (1).
227. Pterygoid: without basal process (0); with basal process (1).
228. Carpus: more than four free carpals (0); four free carpals (1); three or fewer free carpals (2).
229. Ulnare: simple, discoid or quadrangular but not "V-shaped" (0); ulnare elongate, rod-like (1); replaced during development by a "V-shaped" element (the pisiform) (2); absent and not replaced by a "V-shaped" element (3). Hinchliffe and Hecht (1984), Hinchliffe (1985).
230. Radiale: simple, discoid, or quadrangular (0); elongate, rod-like (1); articular surface sinuous, complex (2). Walker (1990), Parrish (1993).
231. Carpometacarpus: absent (0); distal carpals and metacarpals partially fused (1); distal carpals and metacarpals completely fused (2).
232. Carpometacarpus, extensor process: absent or poorly developed (0); well developed (1).
233. Manus: pentadactyl (0); digits I, II, III prominent, digits IV and V greatly reduced or absent (1); digits II, III, IV prominent, digits I and V greatly reduced or absent (2); didactyl or with only two well-developed digits (3); reduced to a single digit (4).
234. Second (topographical) metacarpal: unmodified (0); more robust than other metacarpals (1). Modified from Zhou and Martin (1999).
235. Third (topographical) metacarpal: unmodified (0); bowed (1); slender, appressed to the second (topographical) metacarpal (2); greatly reduced or absent (3). Modified from Gauthier (1986) and Zhou and Martin (1999).
236. Third (topographical) metacarpal slants ventrally towards distal end: absent (0); present (1). Modified from Zhou and Martin (1999).
237. Third (topographical) metacarpal: does not project distally more than second (topographical) metacarpal (0); projects distally beyond second (topographical) metacarpal (1). Chiappe and Walker (2002).
238. Second (topographical) digit, first phalanx posterolaterally expanded: absent (0); present (1). Modified from Zhou and Martin (1999).
239. Third (topographical) digit, phalanx count: four or more (0); one–four (1); zero (2).
240. Third (topographical) digit, proximal phalanx: similar in size to or smaller than the second phalanx of the digit (0); more than or equal to twice the length of the second phalanx (1). Modified from Senter et al. (2004).
241. Third (topographical) digit: without any characteristic "twist" (0); phalanges twisted about long axis with distal articular condyles directed medially when in articulation (1). Modified from Wagner and Gauthier (1999) and Gishlick (2001).
242. Ascending process of astragalus: absent (0); present (1).

NOTES

¹ Although widely discussed in connection with the origin of birds (e.g., Whetstone and Martin 1979; Walker 1985, 1990; Chatterjee 1991; Gower and Weber 1998), a metotic fissure character has not, to our knowledge, been used in cladistic analyses of the origin of birds. Terminological confusion and conflicting accounts of the development of the metotic fissure have plagued these discussions, but Rieppel (1985) and more recently Gower and Weber (1998) offer excellent reviews and figures. Briefly, the metotic fissure is a gap in the embryonic skull of reptiles and birds, between the basal plate of the basicranium and the occipital arch on one side and the otic capsule on the other side (de Beer and Barrington 1934, Rieppel 1985). During development, this gap is restricted by the growth of a basicapsular commissure extending posteriorly from the root of the facial (VII) nerve. The glossopharyngeal (IX), vagus (X), and accessory (XI) nerves and a vein (probably the internal jugular vein) traverse the remaining portion of the gap. If this gap remains undivided into maturity, the opening should be referred to as the "metotic foramen" (Gower and Weber 1998). In the adult skull it is located posteroventral to the fenestra ovalis (into which the footplate of the stapes fits).

In most archosaurs the metotic foramen remains undivided, but in crocodylomorphs, birds, and some theropods, the metotic foramen is subdivided. In birds and crocodylian crocodylomorphs, for which developmental data are available, an osseous "prevagal commissure" develops that separates the metotic fissure–foramen into anterior and posterior parts (Rieppel 1985, Gower and Weber 1998, Gower and Walker 2002). The anterior part of the subdivided metotic foramen, housing the perilymphatic sac, is properly referred to as the "recessus scalae tympani" (Rieppel 1985, Gower and Weber 1998). The route of the perilymphatic duct is shifted during the subdivision of the metotic fissure–foramen such that through the lateral aperture of the recessus scalae tympani, the perilymphatic sac fuses with the tympanic mucous membrane, forming a secondary tympanic membrane (Whetstone and Martin 1979, Gower and Weber 1998). This membrane stretches across the osseous frame of the lateral aperture of the recessus scalae tympani; together they are properly referred to as the "fenestra pseudorotunda." The more posterior aperture of

the subdivided metotic foramen transmits cranial nerves X–XII and the internal jugular vein and should be referred to as the "vagal" or "jugular foramen" (Gower and Weber 1998). These vessels are shunted posteriorly toward the occiput, and ultimately cranial nerves X–XII and the internal jugular vein exit posteriorly on the occiput (Walker 1985, 1990; Gower and Weber 1998; Gower and Walker 2002). In early evolutionary stages, the jugular–vagal foramen may lie close to the fenestra pseudorotunda, but it would still be distinct from this opening.

The homology of the prevagal commissures subdividing the metotic fissure–foramen in birds and crocodylians has been debated (e.g., de Beer and Barrington 1934; de Beer 1937; Whetstone and Martin 1979; Rieppel 1985; Walker 1985, 1990; Chatterjee 1991; Gower and Weber 1998), but the balance of evidence indicates that these structures are homologous (*pro*, de Beer and Barrington 1934; de Beer 1937; Whetstone and Martin 1979; Walker 1985, 1990; *contra*, Rieppel 1985, Chatterjee 1991; see also the extensive review by Gower and Weber 1998). Gower and Weber (1998:398) correctly observed that the homology of the avian and crocodylian structures has "perhaps prematurely been considered as (negatively) resolved in the wake of the currently favoured 'theropod hypothesis' of avian origins."

Safely inferring the presence of a true fenestra pseudorotunda requires evidence of a prevagal commissure subdividing the metotic foramen; putative correlates (presence of a lateral ridge on the exoccipital, shift in the orientation of the perilymphatic foramen, etc.) are insufficient. A clear structure that can be referred to as the "fenestra pseudorotunda" must exist for the derived condition to be considered present (Gower and Weber 1998). We used this criterion when formulating and coding a metotic fissure character for inclusion in our analysis. For example, we coded *Dibrothosuchus* as having a subdivided metotic fissure because such a structure is clearly visible (Wu and Chatterjee 1993), whereas *Dromaeosaurus*, in which a fenestra pseudorotunda is merely inferred to be present on the basis of putative correlates (Currie 1995), was not coded with the derived state because the metotic fissure was clearly not subdivided (state 0) and was only assumed to be subdivided. The same criterion was used in coding the metotic fissure as subdivided in the other 11 taxa (including some birds, other crocodylomorphs, and some maniraptorans) for

which the derived state is listed as present in our matrix.

² Dental morphology and patterns of tooth implantation in birds and other archosaurs have been widely discussed since Martin et al.'s (1980) demonstration that Mesozoic birds, including *Archaeopteryx*, share with crocodyliform crocodylomorphs almost identical dental morphologies and implantation systems (see also Martin 1983, 1985, 1991; Martin and Stewart 1999). In both Mesozoic birds and crocodyliforms, the teeth lack serrations, a constriction appears between crown and root, the root of the tooth is inflated, and interdental plates do not develop (see Martin and Stewart [1999] for an extensive overview). This situation contrasts with that in most theropods, which have serrated, recurved teeth with extensive interdental plates, as in archosaurs primitively. Martin et al. (1980), Martin (1983, 1985, 1991), and Martin and Stewart (1999) argued that these data supported the crocodylomorph hypothesis of bird origins first put forward by Walker (1972). Currie (1987) attempted to identify similar features in the dentition of troodontids. Elements of Martin et al.'s (1980) original argument have been criticized by other researchers who have sought to show that the dentition and implantation style of the teeth in *Archaeopteryx* is more similar to that of theropods than Martin et al. (1980) realized (e.g., Elzanowski and Wellnhofer 1996, Elzanowski 2002).

In recent years, the sharp dichotomy between the avian-crocodyliform dental morphology and mode of implantation on the one hand, and theropod dental morphology and mode of implantation on the other, has clearly become untenable. Numerous maniraptorans have combinations of avian-crocodyliform dental characters (Weishampel et al. 2004, and references therein), and some maniraptorans, like *Byronosaurus*, a troodontid, appear to share the entire suite of avian-crocodyliform dental characters (Makovicky et al. 2003; see also Norell and Hwang 2004). Moreover, as is now known from studies of mammals (e.g., Naylor and Adams 2001, and references therein), dental characters are considerably more plastic than once realized. Nonetheless, these characters are potentially phylogenetically informative in discriminating among competing hypotheses about the origin of birds and, therefore, were included in our analysis.

³ Although interclavicle characters have not, to our knowledge, been used in cladistic analyses

of the origin of birds, Sereno (1991) used the absence of an interclavicle as a synapomorphy of the Ornithodira, which he defined as "Pterosauria, *Scleromochlus*, Dinosauromorpha (including birds), and all descendants of their common ancestor" (p. 34). Padian (2001b:492) went further and claimed that the interclavicle is "lost or unknown in most archosaurs." Padian (2001b) follows Gauthier (1986) in restricting the name Archosauria to the crown group (the Avesuchia of Benton [1999]), but even so this statement is incorrect. Interclavicles are present in "sphenosuchian" crocodylomorphs and crocodylians (Reese 1915, Mook 1921, Walker 1972, Crush 1984, Wu and Chatterjee 1993), and the interclavicle is present in carinate neornithine birds, where it is incorporated into the sternum, contributing to the carina (Parker 1891, Romanoff 1960, Martin 1991). Following the argument of Bellairs and Jenkin (1960) that the hypocleidium of the furcula might be homologous with the interclavicle, Martin et al. (1998a) argued that the exaggerated hypocleidium of Enantiornithes (in most taxa it is 75% the length of the furcular rami; Chiappe and Walker 2002) was formed by the interclavicle. According to this argument, in enantiornithine birds the interclavicle was incorporated into the furcula rather than into the sternum as a prominent carina, as in carinate neornithines.

Norell and Makovicky (1999) argued that the hypocleidium in birds could not be homologous to the interclavicle because the interclavicle is absent in ornithodirans and birds are ornithodirans, but this is a circular argument. They cited Russell and Joffe's (1985) study of the early development of the furcula in *Coturnix* as supporting their view, but Russell and Joffe's work only reiterates the earlier conclusion (e.g., Heilmann 1926) that the interclavicle is not part of the furcula in neornithines. Martin et al. (1998a) did not argue that the hypocleidium and interclavicle were homologous in all birds, but that they were homologous only within the enantiornithines. Thus, Russell and Joffe's study supports Norell and Makovicky's (1999) argument that the interclavicle and hypocleidium are distinct elements only insofar as this argument pertains to ornithurine birds. Padian (2001b) argued that, because the interclavicle was "lost or unknown" in most crown-group archosaurs, Martin et al. (1998a) were mistaken; but, as noted above, Padian was incorrect about the distribution of the interclavicle in crown-group archosaurs.

We coded the enantiornithine taxa in our analysis as having the interclavicle incorporated into the furcula, and we coded carinate ornithurine taxa as having the interclavicle incorporated into the sternum.

⁴ The homology of the avian furcula has been contentious (e.g., Bryant and Russell 1993, Hall 2001), in spite of the common assertion that the furcula of birds is formed by medial fusion of the clavicles of reptiles (e.g., Baumel and Witmer 1993). The furcula has long been considered a character vital to an understanding of the origin of birds. In his famous treatise, Heilmann (1926) argued that, because theropods lacked clavicles, they could not have given rise to birds, because they could not have evolved a furcula. Structures identified as fused clavicles forming furculae have now been reported in several theropod taxa, including ceratosaurs (Tykoski and Rowe 2004), *Allosaurus* (Chure and Madsen 1996), tyrannosauroids (Makovicky and Currie 1998), oviraptorosaurs (Osmólska et al. 2004), troodontids (Xu and Norell 2004), and dromaeosaurs (Norell and Makovicky 2004). The presence in theropod dinosaurs of structures possibly homologous with the avian furcula has been considered particularly significant (e.g., Padian 2001b, Paul 2002), but furcula-like structures have also been identified in early archosaurs like *Longisquama* (Sharov 1970; Jones et al. 2000, 2001) and prosauropod dinosaurs (Yates and Vasconcelos 2005), and they also seem to be present in at least one group of nonarchosaurian diapsids, the drepanosaurs (Harris and Downs 2002). Despite potential homology problems, and because of the historical significance of the furcula as a character in avian evolution, we followed the consensus among ornithologists and regarded the furcula as homologous with the reptilian clavicles. This decision may have to be revised in the future.

APPENDIX 3: ANALYSIS OF CHARACTERS
IN THE MANUS, CARPUS, AND TARSUS THAT
WERE EXCLUDED FROM THE PRIMARY
ANALYSIS OF OUR NEW MATRIX

MANUS

Among archosaurs, only birds and some neotetanurine theropods (the Carnosauria and Coelurosauria, equivalent to Avetheropoda of Holtz et al. [2004]) have a manus with only three digits (e.g., Ostrom 1976a, Gauthier 1986, Wagner

and Gauthier 1999). In particular, the manus of maniraptorans is similar in overall morphology to that of *Archaeopteryx* (e.g., Ostrom 1976a, Gauthier 1986, Wagner and Gauthier 1999, Paul 2002). This similarity has lent support to the BMT hypothesis. In theropods, and in dinosaurs primitively, the pattern of digital reduction appears to have been postaxial and asymmetrical with the reduction or loss of digits IV and V (Gauthier 1986, Wagner and Gauthier 1999). Both basal saurischians and basal ornithischians show evidence of this pattern of digital reduction (Weishampel et al. 2004, and references therein). Therefore, if the tridactyl manus of birds and neotetanurine theropods are homologous, then the manus of birds should be composed of digits I, II, and III. The phalangeal formula of the manual digits of *Archaeopteryx* is 2-3-4, corresponding to the first three digits of the pentadactyl manus of primitive archosaurs and supporting the contention that the manual digits of birds are I, II, III (Ostrom 1976a, Gauthier 1986, Wagner and Gauthier 1999, Paul 2002).

Unfortunately, a conflict between the paleontological and embryological evidence casts doubt on the homology of the avian and theropod manual digits. Embryological evidence from *Gallus* and *Struthio* suggests that the manual digits of birds are the second, third, and fourth of the pentadactyl manus of primitive archosaurs (Hinchliffe and Hecht 1984, Hinchliffe 1985, Burke and Feduccia 1997, Feduccia 1999, Feduccia and Nowicki 2002, Kundrát et al. 2002, Larsson and Wagner 2002, Feduccia et al. 2005; but see Welten et al. 2005). Whereas in dinosaurs digits IV and V were reduced or lost and the first, second, and third digits of the pentadactyl manus of primitive archosaurs were retained, in birds the digital reduction pattern appears to be symmetric around digit III.

To account for the discrepancy, Wagner and Gauthier (1999) and Vargas and Fallon (2005a, b) have suggested that a homeotic frame shift must have occurred during the evolution of neotetanurine theropods, whereby the expression domains of genes such as the Hox d group were repositioned in the limb bud (see also Wagner 2005). According to this hypothesis, embryonic condensations II, III, and IV give rise in adult birds to digits corresponding to the first, second, and third digits of the pentadactyl manus of primitive archosaurs, thereby restoring digital homology between theropods and birds. Dahn and Fallon

(2000) and Drossopoulou et al. (2000) found that a homeotic frame shift such as that proposed by Wagner and Gauthier (1999) can be produced in the laboratory by manipulation of the normal development of the limb bud, and Vargas and Fallon (2005a, b) argued that molecular evidence supports the frame-shift hypothesis. Some molecular studies have retrieved different results, however (Welten et al. 2005), and Galis et al. (2005) and Feduccia et al. (2005) have shown that the molecular evidence advanced by Vargas and Fallon (2005a, b) is inconclusive. Feduccia (2002), Galis et al. (2003, 2005), and Feduccia et al. (2005) argued that, even though it is theoretically possible, the frame-shift hypothesis is biologically implausible, especially given constraints on autopod development in amniotes and the absence of any clear adaptive advantage achieved through dramatic alterations of normal autopod development. Known examples of frame shifts in amniotes are on a smaller scale (Feduccia et al. 2005). Prum (2002, 2003) has argued that if the digits of the avian hand are II, III, and IV, then explaining the phalangeal formula of *Archaeopteryx* will require postulating transformations during autopod development that are similar to those postulated by the frame-shift hypothesis. If the digits of *Archaeopteryx* were really II, III, and IV, a symmetrical reduction of one phalanx per digit would have had to occur to yield the observed phalangeal formula of 2-3-4. Feduccia (1999, 2002, pers. comm.) and Feduccia et al. (2005) contended that this is a simpler and more plausible transformation than a homeotic frame shift; it can occur via blockage of *BMP4* signaling during limb bud development (Zhou and Niswander 1996). Moreover, variation in phalangeal formulae is common in birds, even in the Mesozoic, and pedal phalangeal formulae even vary in some specimens of *Archaeopteryx* (Feduccia 2002, Feduccia et al. 2005). Feduccia (2002) and Feduccia et al. (2005) further noted that the frame-shift hypothesis fails to account for all of the embryological evidence. Demonstration of the presence of all five digits in the manus of birds, with digits II, III, and IV prominent, indicates that the manus of birds was primitively pentadactyl, with digits I and V reduced, the common pattern of digital reduction in amniotes. These embryological data for the normal development of birds indicate that the direct ancestral lineage of Aves was characterized by a pentadactyl manus with digits II, III, and IV predominant (Feduccia 2002, Feduccia and Nowicki 2002, Kundrát et al. 2002,

Feduccia et al. 2005). This ancestral character state is incompatible with the manual morphology of basal saurischians and theropods, because these taxa are committed to a postaxial, asymmetrical pattern of digital reduction, with digits I, II, and III predominant (Wagner and Gauthier 1999, Feduccia 2002, Feduccia et al. 2005). The frame-shift hypothesis, even if accepted, does not explain this discrepancy.

In an effort to resolve these uncertainties, Galis et al. (2003) suggested that neotetanurine theropods may have retained digits II, III, and IV instead of I, II, and III. This interpretation, if correct, would mitigate the discrepancy between the embryological and paleontological data and would render the frame-shift hypothesis unnecessary, but Larsson and Wagner (2003) have criticized Galis et al.'s (2003) proposal. Given that a postaxial, asymmetrical pattern of digital reduction appears to be primitive within Dinosauria, the proposal of Galis et al. (2003) is difficult to support.

Clearly, the present data concerning the identity of the manual digits of both birds and theropods are ambiguous. Of course, the digits of birds and theropods would be homologous if birds were theropods, and the digits of birds and maniraptorans would be homologous if maniraptorans were birds, but the data are not sufficient to establish these homologies at present, and any scoring of the manual digits for birds and theropods does not acknowledge the uncertainties in the data. In addition, these uncertainties complicate comparisons of the avian and theropod manus with the manus of archosaurs in general.

CARPUS

Evaluation of carpal homologies among birds and theropods is difficult. The highly derived carpus of neornithine birds is not easily compared with the carpus of either Mesozoic birds or theropods. The considerable morphological variation in the carpus of theropods is often poorly understood. Furthermore, homologies in the avian and theropod carpus are contingent upon digital identity, and the digital identities of theropods and birds remain uncertain. Even if this issue is disregarded, seven more arise: (1) disappearance of the avian ulnare and development of the pisiform, (2) homology of the proximal carpals in Maniraptora, (3) distribution of proximal carpals in nonmaniraptoran theropods, (4) homology of

the radiale within Aves and between birds and theropods, (5) homology of the semilunate carpal within Aves, (6) homology of the semilunate carpal within Theropoda and between theropods and birds, and (7) identification of distal carpals without knowledge of digital identity. Comparisons among birds, theropods, and other archosaurs for these characters are compromised by the ambiguity of the data.

Disappearance of the avian ulnare and development of the pisiform.—A V- or U-shaped proximal bone in the neornithine carpus is identified as the ulnare by Baumel and Witmer (1993). Hinchliffe (1985) observed that the reptilian ulnare is present as a cartilaginous element in the embryonic chicken carpus at 5.5 days of development but that, by day 7.5, the true ulnare has stopped synthesizing matrix, undergone cell death, and disappeared (Fig. 4). Subsequently, a V- or U-shaped pisiform develops (Figs. 4 and 5). Hinchliffe and Hecht (1984) have detected this developmental pattern in the embryos of anseriforms, charadriiforms, galliforms, spheniscids, and *Struthio*. It may be primitive for Neornithes. These conclusions have been generally accepted in the ornithological literature, despite the persistence of the term “ulnare” on grounds of entrenched usage (e.g., Baumel and Witmer 1993, Feduccia 1999). In a recent study on the development of the wing basipodium in *Struthio*, however, Kundrát (2008) argued that the ulnare is replaced not by the pisiform but by a proximal carpal element of uncertain identity, which he identified as the pseudoulnare. These data complicate assessment of the basal pattern for Aves and further complicate comparison of the avian carpus with that of other archosaurs.

No developmental data for the carpus of theropods are available to indicate whether a similar process occurred, and it is unclear whether any theropods possessed a pisiform, much less a pseudoulnare (see below). Assessing the homology of the avian “ulnare” and the theropod ulnare, or of the avian pisiform and a theropod pisiform, or of an avian pseudoulnare and a theropod pseudoulnare, if any of these elements were in fact present in theropods, is therefore impossible.

Homology of the proximal carpals in Maniraptora.—Confusion remains about the identities of the proximal carpal elements in Oviraptorosauria, Dromaeosauridae, and Troodontidae. In oviraptorosaurs, a carpal usually associated with the radius may be the radiale, but because it shifts

positions in some specimens, its identity is uncertain (Osmólska et al. 2004). In *Ingenia*, a carpal associated with the topographically third metacarpal may be the corresponding distal carpal, but in *Caudipteryx*, a similar element is ventral to the ulna, and Zhou et al. (2000) labeled it an “ulnare.” Osmólska et al. (2004) were uncertain about its identity. With the exception of basal forms, the dromaeosaur carpus has only two elements, a semilunate distal carpal and a proximal carpal. Ostrom (1969) mistook the semilunate carpal of *Deinonychus* for the radiale, but it is, in fact, a distal element (Padian 2001b, Paul 2002); he suggested that the other carpal in *Deinonychus* was the ulnare, but it may be the radiale or even another carpal entirely; we presently have no way of knowing (Norell and Makovicky 2004). The situation in troodontids is equally uncertain: the carpus is known only for *Sinornithoides*, which possesses two elements identified as a semilunate carpal and a radiale (Russell and Dong 1993a). Again, however, we have no way of knowing whether this proximal element actually is the radiale. Given these data, the Oviraptorosauria, Dromaeosauridae, and Troodontidae cannot currently be coded for these characters.

Distribution of proximal carpals in nonmaniraptoran theropods.—Uncertainty about the distribution of proximal carpals in nonmaniraptoran theropods involves the ulnare, the intermedium, and the pisiform.

An ulnare is apparently present in the coelophysoid ceratosaur *Syntarsus* (= *Coelophysus*; see Paul 2002), along with a radiale and intermedium (Tykoski and Rowe 2004), but neotetanurines may primitively lack an ulnare, given that no ulnare is preserved in the carpus of *Allosaurus*, although a radiale and an intermedium are preserved (Chure 2001). The situation in coelurosaurs is unclear. Hwang et al. (2004) identified a small discoidal carpal between the ulna and radius in *Huaxiagnathus* as an ulnare, but this conclusion is unlikely. First, the ulnare may be absent in neotetanurine outgroups to the Coelurosauria; second, the position of this carpal between the ulna and radius is more congruent with its being an intermedium; and third, this position cannot be explained by post-mortem distortion, because the carpal in question is preserved in the same position in both wrists of the type specimen (CAGS-IG02-301; see fig. 8 of Hwang et al. 2004). Similar considerations apply to the carpal identified as an ulnare in *Sinosauropteryx* by Currie and Chen (2001). Currie and Chen

(2001) also reported that a pisiform is present in *Sinosauropteryx*, but the element in question could equally well be a disarticulated manual phalanx, and a pisiform is apparently absent in all other theropods. The situation in ornithomimosauria is confusing. In their description of *Sinornithomimus*, Kobayashi and Lü (2003) stated that, among the proximal carpals, an ulnare and an intermedium are present, but their picture of the carpus of IVPP V 11797-18 (Kobayashi and Lü 2003, fig. 16B) does not seem to corroborate this interpretation. Kobayashi and Lü's "intermedium" is on the far medial side of the carpus, distal to the radius. It is not positioned between the radius and ulnare, as the intermedium ought to be. Given the tight articulation of the wrist in this specimen, the carpal in question is unlikely to have been displaced. This carpal is probably the radiale, not the intermedium. The structure that Kobayashi and Lü (2003) labeled "ulnare" is positioned distal to the ulna but is also closely applied to the topographical third metacarpal. It could as easily be interpreted as a distal carpal. These ambiguities complicate our understanding of the basal condition for Ornithomimosauria and, by extension, of the basal condition for Maniraptoriformes.

These data do not make clear which proximal elements were retained in nonmaniraptoran theropod evolution. Some elements, like the ulnare and intermedium, may have been lost and reacquired repeatedly. Determination of whether they were is complicated by uncertainties in interpreting the available fossils. A pisiform does not appear to be unambiguously present in nonmaniraptoran or maniraptoran theropods. Until further data clarify trends in the evolution of proximal carpals within the Theropoda, coding theropods for these characters cannot be justified.

Homology of the radiale within Aves and between birds and theropods.—On the basis of a study of the development of the wing basipodium in *Struthio*, Kundrát (2008) has argued that the radiale of neornithines is a composite element formed by the fusion of the radiale *sensu stricto* and the intermedium. Assessment of whether the radiale of Mesozoic birds is a composite element is impossible without developmental data. Therefore, the homology of the radiale within Aves cannot be assessed. Given the uncertainty with respect to the distribution of the intermedium and radiale *sensu stricto* within Theropoda (inclusive of maniraptorans; see above), combined with the absence of developmental data, it is also impossible

to determine whether a "radiale," if present in a theropod taxon, would be homologous with the avian radiale.

Homology of the semilunate carpal within Aves.—A distal semilunate carpal is found in embryonic but not adult neornithine birds. During development of the carpus, it fuses to the metacarpals to form the carpal trochlea, a component of the carpometacarpus (Trochlea carpalis; Baumel and Witmer 1993). Hinchliffe documented the presence of two elements in the distal row of the carpus of the embryonic skeleton of the chicken wing (see figs. 9–10 of Hinchliffe 1985; our Fig. 5). One element is associated with the middle metacarpal (identified by Hinchliffe as metacarpal III), and Hinchliffe (1985:144) refers to it as "distal carpal III." The other element in the distal row is of unknown identity. It is located just distal to the outer metacarpal (identified by Hinchliffe as metacarpal IV); it was noted by Montagna (1945), who labeled it "X." Hinchliffe's distal carpal III fuses to the outer metacarpal at its radial (medial) edge, whereas at its ulnar (lateral) edge it fuses with element "X." Later, this semicircular structure fuses to the inner metacarpal and then, finally, to the middle metacarpal, forming the crescentic carpal trochlea in the adult bird (Fig. 5). Kundrát (2008), on the basis of a study of the development of the wing basipodium in *Struthio*, argued, against Hinchliffe (1985), that the semilunate carpal is formed from the fusion of distal carpals II–IV, and he suggested that this pattern is primitive for Aves. No means is currently available to determine whether he is correct.

In *Archaeopteryx* and other basal birds, a prominent semilunate carpal persists in the adult carpus. It remains free of the metacarpus in *Archaeopteryx*, but in some basal birds, like *Confuciusornis*, it may be partially fused to the metacarpus. If Aves is monophyletic, then the process by which the semilunate develops in neornithine birds may be primitive to all birds, but Zhou and Martin (1999:291, fig. 3) have identified a small free carpal (possibly a distal carpal) in *Archaeopteryx* as the element "X" identified by Hinchliffe (1985), stating that only in modern birds does element "X" fuse to the semilunate carpal. If so, the semilunate of *Archaeopteryx* formed differently from the semilunate of modern birds, and the two may not be homologous. If Kundrát's (2008) analysis of the development of the avian semilunate carpal is correct, however, the semilunate carpals of *Archaeopteryx* and modern birds may

be homologous. Without further data on the homologies of the elements that form the carpal trochlea of neornithines, and without data clarifying homologies in the carpus of Mesozoic birds, the homology of the semilunate carpal within Aves is, at present, uncertain.

Homology of the semilunate carpal within the Theropoda and between theropods and birds.—Many researchers have identified structures in the theropod carpus as semilunate carpals formed from the fusion of distal carpals I and II, and they have considered them homologous with the semilunate carpals of birds. Semilunate carpals have been identified in the basal tetanurines *Xuanhanosaurus* (Holtz et al. 2004); the spinosaurid *Afrovenator* (Serenó et al. 1994); possibly the neotetanurine *Allosaurus* Chure (2001); the basal coelurosaurian compsognathids *Huaxiagnathus* and *Sinosauroptryx* (Currie and Chen 2001, Hwang et al. 2004); the basal tyrannosauroid *Guanlong* (Xu et al. 2006); possibly the derived ornithomimosaur *Struthiomimus* (Nicholls and Russell 1985, Barsbold and Osmólska 1990); the therizinosauroids *Falcarius*, *Alxasaurus*, and *Beipiaosaurus* (Russell and Dong 1993b, Xu et al. 1999b, Kirkland et al. 2005b, Zanno 2006); and the Oviraptorosauria, Dromaeosauridae, and Troodontidae (e.g., Makovicky and Norell 2004, Norell and Makovicky 2004, Osmólska et al. 2004). The carpus of the alvarezsaurids is too derived to be interpretable because the carpals are fused into a carpometacarpus (Chiappe et al. 2002).

Establishment of the homology of the semilunate carpal within the Theropoda is difficult. Only in the maniraptoran clades Oviraptorosauria, Dromaeosauridae, and Troodontidae is a prominent semilunate distal carpal with trochlear surfaces present. In nonmaniraptoran theropods, the elements identified as semilunate carpals are small and only vaguely semilunate, and they lack trochlear surfaces. Padian and Chiappe (1998) regarded fusion of distal carpals I and II sufficient to indicate that a semilunate carpal homologous to that of birds is present. Note, however, that although assumptions of fusion in carpalia are common, they are often inferred without any evidence; genuine loss may be as common as or more common than fusion of separate elements (Romer 1956). Contrary to Padian and Chiappe (1998), Chure (2001) argued that a trochlear surface must be present for a carpal to be considered a semilunate. If so, the "semilunate carpal" of nonmaniraptoran theropods cannot

be homologous with the semilunate carpals of maniraptorans (Chure 2001). Xu et al. (2006) concurred with Chure (2001), but Holtz (2001) supported the homology of the semilunate carpals in nonmaniraptoran and maniraptoran theropods and considered the semilunate diagnostic of a large clade of theropods, perhaps the Tetanurae.

Establishment of the homology of the semilunate carpal within the Theropoda is further complicated by uncertainties concerning the basal conditions for Neotetanurae, Coelurosauria, Maniraptoriformes, and Maniraptora. The putative semilunate carpal of *Allosaurus* may be a single distal carpal (Chure 2001); if so, it would not be a semilunate carpal by the criteria of either Padian and Chiappe (1998) or Chure (2001), so a semilunate carpal may be primitively absent in the Neotetanurae. If compsognathids were basal maniraptorans (Hwang et al. 2004) rather than basal coelurosaurs (Forster et al. 1998, Sereno 1999, Holtz et al. 2004), a semilunate carpal might be primitively absent in coelurosaurs, although Xu et al. (2006) reported the presence of a putative semilunate carpal in the basal tyrannosauroid *Guanlong*. Even if a semilunate carpal were primitively present in coelurosaurs, it does not appear to be primitively present in Maniraptoriformes, given that no basal ornithomimosaur possess one (Barsbold and Perle 1984, Barsbold and Osmólska 1990). Although the basal therizinosauroid *Falcarius* was described as having a semilunate carpal, in some specimens no semilunate carpal is present (Zanno 2006), which suggests that therizinosauroids may primitively lack a semilunate carpal. If they do, the basal condition for Maniraptora is unclear. These ambiguities clearly indicate that the homologies of the semilunate carpal within Theropoda cannot presently be resolved.

Homology of the semilunate carpals of theropods and birds is also difficult to establish. Although Chure (2001) argued that a trochlear surface must be present for a carpal to count as a semilunate, he did not dispute the widespread assumption that semilunate carpals of theropods are composed of the fused distal carpals I and II (e.g., Padian and Chiappe 1998), but if the semilunate carpals of theropod taxa, including maniraptorans, are composed of fused distal carpals I and II, then the theropod semilunate carpal cannot be homologous with the semilunate carpal of neornithines, which is composed of distal carpal III and an unidentified lateral element X (Fig. 5; Hinchliffe 1985). Even if Kundrát (2008)

were correct in arguing that the semilunate carpal of neornithines is composed of fused distal carpals II–IV, the semilunate carpal of theropods would still not be homologous with the avian semilunate carpal if, as Padian and Chiappe (1998) and others have asserted, the theropod semilunate is composed of fused distal carpals I and II. The similarity of the semilunate carpals of oviraptorosaurs, dromaeosaurs, troodontids, and Mesozoic birds is not, by itself, sufficient to imply homology, and the homologies of the semilunate carpals in these taxa cannot presently be independently assessed. Therefore, even if the uncertain digital identities of theropods and birds are disregarded, the homology of the theropod and avian semilunate carpals clearly cannot be established at present.

Identification of distal carpals without knowledge of digital identity.—Distal carpals are identified by reference to the digits with which they are associated, so which distal carpals are present in birds or theropods cannot be determined before the digital identities of birds and theropods have been ascertained. Clearly, neither birds nor theropods can be scored for these characters until the digital identities of birds and theropods have been resolved.

TARSUS: ASCENDING PROCESS OF THE ASTRAGALUS

In birds and theropods, a sheet of bone that braces the anterior face of the tibia is usually called the “ascending process of the astragalus” or simply the “ascending process.” It is less evident in adult neornithines than in juvenile (or embryonic) neornithines and Mesozoic birds. This sheet of bone is particularly conspicuous in basal birds, including *Archaeopteryx*. This common feature has consistently been regarded as one of the most striking homologies shared by birds and theropods (e.g., Paul 2002), but comparative anatomical research reveals that establishing the homologies of the ascending processes of theropods and birds is difficult.

In neornithines a triangular, late-developing cartilage appears, after fusion of the proximal tarsals, on the lateral face of the tibia, dorsal to the calcaneum (Martin et al. 1980, and references therein). Subsequently, this cartilage fuses with the calcaneum, with which it is primarily associated in both Mesozoic and modern birds (Martin et al. 1980; Fig. 6). Morse (1872) called

this structure the “pretibial.” Ostrom (e.g., 1976a, 1985) argued that this structure is homologous with a similar structure in the tarsus of theropods (see also Paul 2002), but according to Martin et al. (1980:88) “differences in placement and [the pretibial’s] late appearance during development suggest that it is a uniquely derived character for birds and is properly termed a pretibial bone, rather than an astragalar process.” In contrast to the situation in neornithine and Mesozoic birds, the ascending process of theropods is usually a broad sheet of bone, continuous and exclusively associated with the astragalus (compare Fig. 6A and B).

Seeking to resolve this controversy, McGowan (1984) claimed that the “pretibial” in ratites is actually a continuation of the astragalus and that it is not a separate ossification subsequently fusing with the astragalus. He claimed that the “pretibial” ossification was a part of the cartilaginous precursor of the calcaneum, which he labeled the “calcaneal spur.” This “pretibial” ossified and fused with the astragalus in ratites and with the calcaneum in carinates. McGowan (1985) later modified his position and argued that, in both ratite and carinate birds, the “pretibial” was a derivative of the astragalus, and that the chief difference was the point of fusion, a shift laterally toward the calcaneum being a derived condition in birds (see also Paul 2002). In either version, McGowan’s conclusions would, if correct, obviate the apparent discrepancy between the morphology of the avian and theropod ascending processes.

Martin and Stewart (1985) challenged McGowan’s findings, observing that his use of late-stage embryos obscured the actual relationships of the bones in question. Whereas the youngest embryos McGowan (1984) examined were 12 days old, Martin and Stewart (1985) examined seven-day-old embryos of chickens with completely distinct and still cartilaginous astragali, calcanea, and tibiae. At eight days, a triangular pretibial cartilage appears, as described by Morse (1872), and by nine days this pretibial cartilage fuses with the calcaneal and astragalar cartilages. Martin and Stewart (1985:160) concluded that “ratites and carinates have an ascending process (pretibial bone) separate from both calcaneum and astragalus, but that the position of this process may vary.” They reaffirmed the argument of Martin et al. (1980) that the pretibial ossification is an avian neomorph. Feduccia (pers. comm.)

has confirmed these results with embryos of *Struthio* and suggested that the term “descending process” be used to describe the structure in birds more accurately. Holmgren (1955) also reported that, in the embryonic tarsus of *Struthio*, the pretibial was exclusively associated with the calcaneum.

Welles (1984) claimed that the ascending process in theropods was actually a separate ossification, as in birds, an interpretation based on the crus of a juvenile specimen of *Dilophosaurus*, a coelophysoid ceratosaur (Welles 1984:140, fig. 35). Paul (2002) concurred with Welles’s assessment and suggested that the only difference between the ascending process in birds and the ascending process in theropods was its more or less medial position (more medial in “nonavian theropods” and less medial in birds). He argued that the development of a supratendinal bridge and extensor canal for the tendon of M. Extensor digitorum longus had shifted the pretibial laterally in modern birds, but in at least some *Archaeopteryx* specimens, and in other Mesozoic birds, the pretibial is already laterally positioned, despite the absence of a supratendinal bridge (Martin et al. 1980).

In the absence of embryological data for theropods, it is not possible to determine whether the structure in theropods is actually a continuation of the astragalus or, as per Welles (1984) and Paul (2002), a separate, pretibial ossification homologous with the avian pretibial (“descending process”). Moreover, uncertainty remains about the distribution of this character in other archosaurs. An ascending process is present in dinosauriforms such as *Marasuchus* (= *Lagosuchus*; Welles and Long 1974; fig. 10.14d of Paul 2002) and in the ornithischian *Hypsilophodon* (Galton 1974). An ascending process is also present in sauropods (Upchurch et al. 2004). Were we to accept the small bump on the astragalus of *Marasuchus* as an incipient, but nonetheless discernible, ascending process (Paul 2002, fig. 10.14d; Sereno and Arcucci 1994:64, fig. 10E), we would have as much cause to identify a similar spur of bone on the astragalus of crocodylians as an ascending process (e.g., fig. 20 of Mook 1921, fig. 10.14C of Paul 2002). We do not mean to say that crocodylians possess an ascending process in the sense that theropods do, but this example illustrates that one should use caution in talking about small bumps on little ankle bones.

In a recent development, Mayr et al. (2005, 2007) reported that in the “Thermopolis specimen” of

Archaeopteryx “the astragalus forms a broad ascending process identical to that of theropod dinosaurs” (Mayr 2005:1485). This statement contrasts with the account of Martin et al. (1980), who stated that the pretibial of *Archaeopteryx* was oriented laterally, not medially, and that it was therefore primarily associated with the calcaneum and not the astragalus. The figures of the tarsus in the “Thermopolis specimen” provided by Mayr et al. (2005, fig. 3C; 2007, fig. 12) do not unambiguously support their interpretation. Close examination of figure 12b from Mayr et al. (2007), showing the anterior face of the right tarsus, reveals a spear-shaped extension of bone contiguous with the sheet of bone identified as the ascending process. This spear-shaped extension is clearly part of the “ascending process” and is positioned laterally, nearer the calcaneum (Fig. 6C). As noted above, the pretibial in birds develops as a separate center of ossification, which then expands distally and fuses to the calcaneum, sometimes, as in ratites or falconiforms, developing subsequent contact with the medial astragalus. The shape of the ascending process and its spear-shaped extension in the tarsus of the “Thermopolis specimen” is consistent with this developmental process: initial development of the pretibial, subsequent ventral growth, and contact with the astragalus through medial expansion. The situation is different from that seen in a typical theropod tarsus, such as that of *Albertosaurus*, in which the ascending process is an uninterrupted sheet of bone that dominates the entire lower anterior surface of the tibia (compare Fig. 6A and B with C). Furthermore, the evident line separating the ascending process and proximal tarsals in the “Thermopolis specimen” has the appearance of a suture, in agreement with the assessment offered above. On the basis of the evidence available, the exception to Martin et al.’s (1980) description of the tarsus of *Archaeopteryx* is that, in at least one specimen of *Archaeopteryx*, the pretibial has developed some medial contact with the astragalus.

Clearly, the homologies of these structures in birds and theropods remain uncertain.

APPENDIX 4: DATA MATRIX

The matrix includes 242 characters, of which the first 221 were used in the primary analysis. The last 21 characters in each entry were turned on only for the alternative analysis.

Alligator

0—1 0000 00020 00201 00001 01011 00000 01112
 02-01 10001 0-120 00000 01111 00011 11101 11110
 00202 2001- 21111 10000 00000 00000 01110 10100
 00001 00000 00100 00000 0— -01- 20000 02000
 00000 10001 00002 00010 0-001 10010 100-0 11000
 10010 10001 11100 00010 0?000 00011 00000 00000
 0?

Allosaurus

????0 00000 00011 00100 00111 00000 00000 00000
 00000 10000 01010 01110 01101 00001 00000 000-0
 00000 00000 00000 00000 00100 10000 00001 00100
 00100 01012 00100 00000 0— -1200 21000 00000
 00001 10000 00001 01001 10002 11000 10100 01100
 20010 00000 10000 01020 0???? ????? ????? ???? ??

Alxasaurus

????? ????? ????? ????? ????? ????? ????? ?????
 ????? ????? ????? ????? ????? ????? ????? ?0???
 01000 0??1? 0021? 10??? ????? ????0? ????100 01100
 01012 1?110 01?00 0— -11- 21000 00??0 00?01
 00000 00000 02121 21002 2???? ?0211 11100 31??0
 0??0? ?????0 010?0 ????? ?????? ?????? ???? ??

Apsaravis

????? ????? ????? ????? ????? ????? ????? ?????
 ????? ????? ????? ????? ????? ????? ????? ?1??? —?
 ???-? 1200? 0?1?? ????? ?????? ????1?0 1400? 0????4
 120-0 12?0? 22??1 1???? 411?1 22101 00112 00112
 00112 1002? ??212 20100 000-? 01102 -0101 ??200
 10020 11030 ????? ?????? ?????? ?????? ??

Archaeopteryx

12010 10100 01011 10012 -1001 ????? 11100 01111
 0??00 10000 11120 11111 11??? 000?1 11101 21100
 00202 2000- 21111 10000 0001- 00010 0?00? 101?0
 ?10?0 02?12 02110 00000 0— -1210 41011 21010
 00000 00011 00?02 10121 11011 21000 210-0 00001
 31100 00000 10020 01021 1???? ?????? ?????? ?????? ??

Avimimus

????? ?1?1? ?201? ????12 -?0?1 012-2 13000 10110
 02-11 10011 1???? ?????? 11111 010?? ?1??1 ?????1
 ?1-? — ?-?-? -2??? ?0?00 00011 10310 10101 11101
 0101? ????? ?????? ?????? ?????? ?????? ??????
 00012 0010? ?0021 0-212 11000 10??? ?1110 21001
 20200 10020 11220 ????? ?????? ?????? ?????? ??

Bambiraptor

????0 00000 01011 11002 -1001 01000 01000 10001
 00000 11110 0?1?? ?111? 1?0?0 0???1 11?01 11100

00000 00000 00000 0000? 001?? 10000 00301 11110
 11101 12122 01112 01??1 10101 11210 41001 11110
 00100 00001 00111 12121 21102 21000 21301 11101
 31100 00000 10000 01021 0???? ?????? ?????? ?????? ??

Baptornis

????0 ????? ?????? ?????? ?????? ?????? ????112 ?0??? 1????
 ?????? ?????? ?????? ?????? ?????? ?????? ?????? ??????
 ?????? ?????? ?0??? ????11 10?11 10111 14001 00104
 120-0 12111 2?1?1 1???? 0???1 02101 10010 00020
 00111 10020 0-211 2?100 000-1 ?1112 -0101 21200
 10030 21030 2???? ?????? ?????? ?????? ??

Byronosaurus

?????? 00101 01111 ?1??? ?100? ?????? 1???? ??????
 ?????? ?????? ????120 ?????? 111?1 100?1 11101 11100
 00202 2111- 1111? 10000 00101 101?? ????10 ????1?
 ?1101 01?1? ????0? ?????? ?????? ?????? ?????? ??????
 ?????? ?????? ?????? ?????? ?????? ?????? ?????? 1????
 ?0??? ?????? 0???1 ?????? ?????? ?????? ?????? ??

Caudipteryx

11000 0001? 11011 00012 -1011 01000 01100 0???1
 01000 10000 0???? ?????? ?????? ?????? ?????? ??????
 1120- — 21-1 11211 00000 00010 ???? ????1?0 ?1???
 ?????? ?20-0 0?0?? 1000? ?????? 01000 10000 00001
 0002? ????01 0102? ????12 01010 ?0201 11101 3?1?0
 00000 10000 01020 1???? ?????? ?????? ?????? ??

Ceratosaurus

????0 00100 00011 11100 00111 00000 00000 00002
 00001 00001 0?1?? ?1100 01101 010?1 00?00 000-0
 00000 00000 00000 00000 00100 10000 00101 01100
 06110 11013 10100 01000 0— -01- 21000 00000
 00001 00000 00011 01002 0-002 11000 ?0120 01102
 -0010 00200 10000 11020 0???? ?????? ?????? ?????? ??

Citipati

????0 01010 12011 11002 -2011 01000 11100 01012
 00000 10001 01121 12111 11101 010?1 00?01 11111
 11— — — 11211 00001 00000 1?010 10110 15101
 02123 11100 00011 10111 11211 41000 11000 00001
 00002 00101 00010 0-212 01010 10201 01101 30100
 00000 10000 01020 0???? ?????? ?????? ?????? ??

Coelurus

????? ?????? ?????? ?????? ?????? ?????? ?????? ??????
 ?????? ?????? ?????? ?????? ?????? ?????? ?????? ?0??? ?000?
 ?????? 0???? 01??? ?????? ????0? ????110 11111 00?1?
 ?????1 0???? ?????? ?????? ????0? ?????? ?????? 00001
 00112 0???? ?????? ????00 2???? ?1110 2000? 0?000
 ?????? ?????? ?????? ?????? ?????? ?????? ?????? ??

Compsognathus

0—0 00100 00011 00000 ?0001 01?00 ????? ?????
 ????? 10000 0?1?? ????? 1???? 000?? ????? ?????
 00101 20100 ?000? 00000 0001- 00010 000?0 ?01??
 ?2?0? ?001? ??100 00000 0— -11- 21000 0????
 ????? ????? ????11 0???? ????? 11000 20100 0????
 ????? 2?00? ????10 00020 0???? ????? ????? ?

Conchoraptor

????? 01010 12011 11002 -2011 01000 11100 01010
 00000 10001 01121 12111 ????? ?10?? ????? ?????1
 11— — — 11211 00001 00010 1?31? ?11?? ?1?0?
 02124 1???? ?0?1 ????? ?211 41000 11000 00001
 00002 00??? ?1011 0-212 01010 10??? ?1101 301??
 ?000? ????? 0102? 0???? ????? ????? ????? ?

Confuciusornis

12000 11100 11010 00012 -2001 01101 11100 0?111
 02-01 10001 1???? ????? ????? ????? ????? ?????1
 11— — — 11101 00000 00111 1?0?? ?11?? ?3001
 12124 120-0 11001 20111 10210 01010 12100 00?00
 10002 00101 00120 0-111 21000 010-1 01112 -0101
 00200 10020 11020 2???? ????? ????? ????? ?

Deinonychus

????? 00000 00011 10100 11001 01000 0000? ?0001
 ?000? ????? 011?0 01111 ????? ?0??? ????? ?????
 00000 00000 00000 1000? 00100 101?0 003?1 10110
 11101 1212? ??112 010?? ????? 101- 21000 11010
 00101 00001 00111 00021 21002 21000 10201 0???1
 31100 00000 10000 01021 0???? ????? ????? ????? ?

Dibrothosuchus

?????1 00000 00010 00001 00011 01000 00000 01112
 02-00 00001 00120 00000 01111 00011 11101 11110
 00201 10000 ?011? 00000 00000 00000 01310 00100
 0100? 00000 0?0-0 00??? 0— -?1- 20000 12000
 00101 10002 00101 0?010 ??000 1???? ????? ?????
 ????? ????? ????? ????? ?0000 00111 00000 000?0 0?

Dilong

0-?? 00000 01011 01000 10011 01010 00000 01??1
 00000 00001 1???? ????? ????0 00??? ????? ??1?0
 00010 000?0 00000 0?000 011?? 110?0 ?1101 ??100
 12??? ??01? ??100 ?0000 0— -11- 21000 01000
 00001 00000 0???? ?0021 1?0?? 11000 2020? 0110?
 2???0 0000? ??000 01020 0???? ????? ????? ????? ?

Dilophosaurus

????? 10000 00010 00100 0000? 00000 00000 00000
 0100? ????? ??1?? ????? 01101 ?00?1 00?0? 000-0
 00000 00000 ?000? 00000 00100 10000 00001

01100 16110 01111 0?100 0???? —?? -11- 20000
 00000 00001 00000 00011 00002 0-002 11000 00120
 01100 10000 00000 10000 01020 0???? ????? ?????
 ????? ??

Dromaeosaurus

????? ?000? 00011 ?0000 1?0?1 ????0 01000 10001
 00000 1111? 011?0 01110 01101 001?1 00001 10000
 00000 00000 00000 10000 00110 10100 003?? ?????
 ????? ????? ????? ????? ????? ????? ????? ?????
 ????? ????? ????? ????? ????? ????? ????? ?????
 ????? ?????1 ????? ????? ????? ????? ?

Effigia

????? 10100 11010 00010 00001 01110 1?000 0????1
 ?0000 10000 1??1? ????? ?1??? ????? ????? ????1
 11— — — 11000 00000 00010 0?10? ??1?0 1????
 00?11 00101 00000 0— -11- 00000 01000 00001
 0002? ????11 ?001? 10001 11000 200-? 0110? ?????
 ?0001 111?0 01010 0?000 00??? 00?00 00??? ?

Enaliornis

????? ????? ????? ????? ????? ????? ????? ??1?? ?2?11
 10001 1???? ????? 11111 00011 11111 2111? ?????
 ????? ????? ????? ????? ????? ????0 ??1?1 14001
 00004 1???? ????? ????? ????? ????? ????? ?????
 ????? ????? ???? ??11? 2???? ????? ?1102 -010?
 ?1200 10030 21030 1???? ????? ????? ????? ?

Eoenantiornis

12100 10100 11010 00012 -???1 1—- ????1 0???1
 ?2-1? 1000? 1???? ????? ????? ????? ????? ?????
 00202 2002- 21111 11000 0001- 00011 ?0??? ?????
 ????? ?????4 12??? 1?100 20011 13222 41011 22101
 01112 10122 00101 0?12? ????12 21100 210- -1112
 -2101 00200 10020 11030 2???? ????? ????? ?????
 ??

Eoraptor

????? 00000 00010 00000 00001 00000 00000 00000
 00000 00000 0???? ????? ????? ????? ????? ?????
 0?202 ????? ?11?? ????? 00000 000?0 ??000 00100
 0?10? 00?01 00101 00000 0— -11- 10000 00000
 00001 00000 00001 00001 0-201 11000 0010? 00000
 00000 00000 10000 01010 0???? ????? ????? ????? ?

Erlikosaurus

????? 00100 01010 00000 00001 01000 01000 00001
 10000 10001 01120 0?1?? 01111 0001? ????1 10101
 00-0 01000 0-110 00210 10000 00011 110?? ?????
 ????? ????? ????? ????? ????? ????? ????? ?????
 ????? 0?000 ????? ????? ????? ????? ????? ?????
 ????? ????? ???? ?1?20 0???? ????? ????? ????? ?

Erpetosuchus

????1 00000 00010 00200 00001 00011 00000 00??2
02-01 00001 00120 0000? ?0?? ???? ???? ????
00202 2000- ?000? ????0 00000 00010 ??100 001?0
0100? 0000? ???? ???? 0— -00- 21000 01000
00-0? 10000 00??2 0?? ???? ???? ???? ????
???? ???? ???? ???? ????00 00?? 00000 00?? ??

Erythrosuchus

????1 00000 00010 00100 00000 01000 00000 00000
00000 00000 0?1?? ?0000 01000 00000 00000 00000
00000 00000 00000 00000 00000 00000 00100
00000 05000 01010 01100 000?? ???? ???? 10000
00000 0000? 00000 00000 00010 0-000 00000 000-0
00003 -0000 00000 00000 00000 0?000 00?? 00000
00?? ?0

Euparkeria

????1 00000 00010 00000 00000 00000 00000 00000
00000 10000 0?0?? ?0000 01000 00000 00000 00000
00100 10000 00000 00000 00000 00000 00300 00000
0100? 0??0 0?0-0 0?00? 0— -00- 11000 00000 00000
00010 00001 00020 0-000 00000 000-0 01003 -???
?0000 00000 00000 0?000 00?? 00000 00?? ?0

Falcarius

???? ?0?0? 0?? ???? ????1 01?? ???? ?1?? ????
?000? ???? ???? 11100 ?00?1 00?01 101?? 00??0
01000 1?11? 0100? 00?? ???? ???? ??10? 111??
???22 0?101 0?300 0— -1?- 21000 01000 00001
00001 00111 02111 21002 11000 10301 11100 2???
00000 100?0 00020 0?? ???? ???? ???? ??

Gallimimus

???? 00001 00011 00010 01001 00111 10000 01001
00000 00001 01120 0001? 01111 100?1 00?01 10101
11— —?- — 11000 0001- -0010 ??101 10110 15100
02012 11001 01?00 0— -11- 21000 01000 00001
00020 00011 01002 10202 11000 10100 01110 20010
00000 10000 01130 3???? ???? ???? ???? ??

Gansus

12100 ????? ???? ???? ???? ???? ???? ????
???? ???? ???? ???? ???? ???? ???? ????
???? ???? ???? ???? ???? ?1? ?1?0 1?00? 02?24
120-0 1?100 22011 12230 41111 22101 10012 01112
11112 10120 0-212 21100 010-? 0??2 -0101 01200
10031 21030 2???? ???? ???? ???? ??

Guanlong

???? 00000 01011 11000 10011 01000 000?? ????
?000? 10001 0?? ???? 01?0? ???? ???? ???? ??

00010 00000 00000 0??0 01100 000?0 0?10? 001?0
11100 0001? 0?1?0 00?0? 0— -11- 21000 00000
00?01 0000? ??01 01011 20002 11000 10000 01100
210?0 00000 100?0 01020 1???? ???? ???? ???? ??

Harpymimus

???? 00001 00011 00000 01001 00?? ???? 0???
?0?00 00000 0?? ???? ???? ???? ???? ????
10— ?000? ?-?? 00010 00000 00011 0??0? ??1?0
??10? 02?23 0?101 01?00 0— -11- 11000 01000
00?01 00020 00011 0?002 ??102 1?0?? ???? ??10?
???? ??000 10000 01030 3???? ???? ???? ???? ??

Herrerasaurus

???? 00000 00010 00000 00001 00000 00000 00000
01000 00000 0?100 011?0 01101 000?? 0?300 ????
00??1 10000 00000 00000 00100 101?0 ??300 00100
00100 00000 00101 0?000 0— -11- 21000 00000
00001 00001 00011 00010 0-102 11000 10100 01100
00000 00000 10000 01010 0?? ???? ???? ???? ??

Hesperosuchus

????1 00000 00010 00201 00001 00011 00000 00102
01-00 00000 0?? ?0?? 11?1? ?00?? ???? ????
00000 00000 0111? 0100? 000?? 0?0?0 ??000 00100
01001 0000? ?0-0 ?0000 0— -0?? 10000 01000
00001 00002 00111 0?? ???? ???? ???? ??1100
0000? 0000? ????0 01010 ???? ????11 00000 00000 0?

Heyuannia

???? ???? ???? ???? ???? 01?? ??100 01??
???? ???? ???? ???? ???? ???? ???? ???? ?1??
—? ????-? 1??1 00001 00011 ??11? ??1?? 1???
??14 1?110 ?2011 1?1?1 ??211 41110 01010 00000
0000? ??211 ?11?? ??112 01010 ?020? 0110? ????
0?? ?0?0 01020 1???? ???? ???? ???? ??

Hongshanornis

12100 1?100 01?? ?012 -??1 ???? 1???? ????
???? ???? 1???? ???? ???? ???? ???? ????
11— — — 1??0 0?01- ???? ?0?? ???? ?1??
???? 1???? 1?010 20011 11231 41011 22101 10?12
0111? ???? ??12? ???? 21100 00?? ???? ????
0?200 100?0 21030 2???? ???? ???? ???? ??

Huaxiagnathus

???? 0?000 00011 00?? ?00? 0?0?? 0?? ????
???? ???? 0?? ???? ???? ???? ???? ???? ????
10100 00000 ???? 0001- ?0?? ???? 001?0 0?0?
???? ??100 00000 0— -1200 21000 00000 00001
0002? ???? 00001 20002 11000 2010? 01100 ????
00000 10000 01020 0?? ???? ???? ???? ??

Iberomesornis

????? ????? ????? ????? ????? ????? ????? ????? ?????
 ????? ????? ????? ????? ????? ????? ????? ????? ?????
 ????? ????? ????? ????? ????? ?1?? -20?? ?0?02
 020-0 12101 2?1?? ?3222 ?11?1 12101 01?1? 0011?
 ??11? ?012? ????? 2???? ?0-? ????? ????? ?0000
 10000 01030 2???? ????? ????? ????? ??

Ichthyornis

????? 11100 1???? ?012 -???? 1— ?112 01111 12-11
 10001 1???? ????? ?11?? ?111 11?01 211?1 00-2
 2001- 2-111 10-0 0011- 00011 11010 10111 13001
 12?24 120-1 1?101 21111 12230 41111 22101 10012
 01102 11112 10?? 0-21? 21100 010-? 01112 -010?
 ?1210 10031 21030 2???? ????? ????? ????? ??

Incisivosaurus

????? 01010 01011 11002 -2011 01000 00000 01??0
 ?0000 10001 01120 0111? 11?0? ?10?? ????? ?????0
 00202 ?010- ?010? 02210 00000 00001 ?1? ????
 ????? ????? ????? ????? ????? ????? ????? ????? ?????
 ????? ????? ????? ????? ????? ????? ????? ????? ?????
 ????? ????? ????? ????? ????? ????? ????? ????? ??

Ingenia

????? 01010 12011 ?1002 -2011 01000 10110 01011
 00001 10001 0???? ????? ????? ????? ????? ?????
 11— — 11211 00001 00011 ?1?? ????? ?????
 ?????4 1?0-0 0???? 10111 11211 41000 01010 00001
 00001 0?000 00011 21112 11010 10201 01101 30100
 00000 10000 01020 0???? ????? ????? ????? ??

Jeholornis

12??0 ????? 11?10 0???? ?1?1? ????? 1???? ?????
 ?????1 00001 ????? ????? ????? ????? ????? ?????
 10— 2000- 2-11 12110 0001- 00010 ?0?? ?1??
 1???? 2?23 11112 0?000 10011 11210 41111 22101
 00012 00011 0?101 00120 0-012 21000 210-1 0????
 ????? ?0000 10020 11021 2???? ????? ????? ????? ??

Juravenator

0—0 00000 00011 00002 -0001 01000 0???? ?????
 ?0000 10000 0???? ????? ????? ????? ????? ?????
 00201 10000 0000? 0???? 0001- 000?? ????? ?1??
 1???? ????? ?010 0 00000 0— -11- 21000 00??
 ?????1 0000? ?0000 00001 ????? ????? ????? ?????
 ?????0 0000? 100?0 01020 0???? ????? ????? ????? ??

Longisquama

?—0 ????? 0??11 ?01? ?10?? 011?? 0???? ?????
 ?????0 ?????0 1???? ????? ????? ????? ????? ?????
 00??2 2000- 2?11? 1???? 0?01- ????? ????? ?????
 0???? ????? ????? ?0000 0— -0210 11010 00000

00?0? 0002? ????00 0???? ????? ????? ????? ?????
 ????? ????? ????? ????? ????? ?0?? 00000 00?? ??

Marasuchus

????? ????? 0???? ????? ????? ????? ????? ?????
 ????? ????? ????? ?1?1 ?0?01 00?0? ????? 0????
 ????? ????? ????? ????? ????? ????0 011?0 0?00?
 00?00 00100 0???? 0— -11- 00000 00000 0000?
 00000 ????0 00010 0-101 11000 000-0 01000 000?0
 00000 10000 01010 0???? ????? ????? ????? ??

Microraptor

12010 10100 01?? ?01? ????? 0???? ????? ?????
 ????? ????? 1???? ????? ????? ????? ????? 00201
 10000 ?111? 1000? 10?? ?1?? ?111 ?1?1 1?01
 10?03 11112 01011 20111 11210 41011 11110 00100
 0000? ?011? ?1111 2111? 21001 21301 11101 31100
 00200 10000 01121 2???? ????? ????? ????? ??

Microvenator

????? ????? ????? ????? ????? ????? ????? ?????
 ????? ????? ????? ????? ????? ????? ????? ?????
 ????? ?2211 00?? ????? ????0 101?0 11101 0101?
 ?0-0 0???? ????? ????? ????? ?0000 00001 00000
 00011 000?1 20012 1?010 1???? ?1100 2010? 0?000
 100?? 0???? ????? ????? ????? ????? ??

Mononykus

????? ????? 0???? ????? ????? ????? ????? ?10? ?????
 ????? ????? ????? ????? ?00?1 11?? 21?0? 0????
 ????- 0?0?0 1???? ????? ????? ????? ?1?1 12001
 1010? ????? ?1?0 22000 0???? 31000 11000 00001
 00000 00010 0???? ?2202 2?0? ?0-1 ?1103 00101
 01200 100?0 012?0 0???? ????? ????? ????? ??

Nothronychus

????? ????? ????? ????? ????? ????? ????? ?????
 ????? ????? ????? 01111 0001? ????01 1010? ?????
 ?????0 0????0 ????? ????? ????? ????0 ?1110 1(1,5)10?
 ?12? ????? ????? ????? ????? ?110? ????? ?????0
 10001 00100 0???? ????? ????? ?031? 0???? ?????
 0000? ????? ????? ????? ????? ????? ????? ??

Ornitholestes

????? 1000? 01011 0000? ?1001 00000 000?0 00??1
 00000 ?0??0 0????0 ????1 0??0? 001?? ????? ?????0
 00010 00000 ?000? 00000 00100 ?0?? ????? ?110
 12101 00012 ?1?1 0???? ????? ????? ????? ?????
 ????? 00001 00?? ?0022 21002 01000 ?0100 0????
 ?010? ????? ?0?0 010?0 0???? ????? ????? ????? ??

Ornithosuchus

?????1 10100 01010 00100 00110 00011 00000 00?00
 ?0100 10000 001?? ?100? 00?? ?00?? ????? ?????

00000 00000 ?000? 00000 00100 10000 00010 ?1?10
0110? 01?01 00100 0????0 — -00- 21000 00000
00001 0000? 1?001 00020 11001 11000 00100 00000
30000 1000? 11100 01010 0?000 00100 00000 000??
00

Oviraptor

????? 1?0?? ?1?11 ?100? ?0?? 0?00? 1???? 1????
????? 1?0?1 ????1 ????0 ????0 ????0 ????0 ????1 11?-
— — 11211 00001 0?011 1???? ????0 ????0 ????0
????? ????0 ????0 ????1 ????0 0???? ????0 ????0
????? ?0021 ????0 ????0 ????0 ????0 ????0 ????0
????? 0???? ????0 ????0 ????0 ????0 ??

Patagopteryx

????? ????? ????0 ?01? ????1 1???? ????1 ?1?1 12-11
????1 1???? ????? 11??? 0???1 11?11 21??? ?0??? ?????
????? ????? ????0 00?1 1??11 10111 14001 00004
1???0 ????0 2???1 1???? 41101 22101 00?0 00012
0011? ?01?? 0-211 21100 00100 01112 -0101 00200
10030 21030 1???? ????0 ????0 ????0 ??

Pelecanimimus

????? 10001 00011 00010 00101 ????? 0???? ?????
????? ?0?? ????0 ????0 ????0 1???? ????0 ????0
00212 2220- ?111? 1?0? 0???? ?00?1 ?1?? ????0
5???? ?0??? ????0 ????0 10000 0???? ?100? ?1000
00??? ????0 ????0 0???? ????0 ????0 ????0 ????0
????? ????0 ????0 ????0 ????0 ????0 ????0 ????0 ??

Postosuchus

????1 00000 00011 00100 00100 00011 00000 01002
02-00 00000 00110 00110 00101 000?1 00100 ?0000
00000 00000 00001 00000 00100 10000 00100 10100
01100 00121 0?100 00000 0— -11- 20000 00000
00001 00000 00110 00000 0-001 11000 20100 00103
00100 10001 11100 00020 0?000 002?? 00000 00000
00

Proterosuchus

????? 00000 00000 00100 00000 00011 00000 00000
00000 10000 00000 00000 00000 00000 00000 000-0
00000 00000 ?000? 00000 0001- 00010 00300 00000
01000 -0000 000-0 00000 0— -00- 00000 00000
00000 00020 00000 00020 0-010 00000 000-0 00?03
00100 00000 00000 00000 0?000 00000 00000 00???
?0

Protopteryx

12000 1110? 11??? ?0012 -???1 011?? ????0 0???01
0???? ????? 1???? ????? ????0 ????0 ????0 ????0 1020-
200?- 21-11 1???? ?01- ????? ????? ????1 ????0 ????4
120-0 1?100 21011 13222 41011 22101 11?10 00112

??101 00120 0-??? 21000 2???? ????0 ????1 00000
10000 11030 2???? ????? ????0 ????0 ??

Rahonavis

????? ????? ????? ????? ????? ????? ????? ?????
????? ????? ????? ????? ????? ????? ????? ????? ?????
????? ????? ????? ????? ????1 ?1?10 11101 02?23
12112 0???? ????? ????? 310?? ????? ????0 ?????
??102 00110 0-002 01?0? ?1301 01102 30100 00100
10000 01031 2???? ????? ????0 ????0 ??

Sapeornis

????? 10100 01010 00012 -1001 0?1?? 011?1 ?????
?0?00 10000 1???? ????? ????? ????? ?????
01202 — 211-1 10000 0001- 0001? ?0?? ?1?10
14?0? ?1?4 120-0 1?000 0— -1211 11011 21010
00000 00002 00100 0?120 0-0?2 21001 210-1 01003
00101 00200 10010 11020 2???? ????? ????0 ????0
??

Saurornithoides

????? 00101 00111 10012 -20?1 01000 0???? ?????
?0?00 10001 0???? ?111? ????1? 100?? ????? ?01?0
00101 111?1 ?111? 0010? 01?0? ????1? ????? ?????
1???? 0???? ?1?0 0???? ????? ????? ????? ?????
????? ????? ????? ????? ????? ????? ????0 ????1 11101
311?? ????? ????0 01121 0???? ????? ????? ?????
??

Scleromochlus

????1 00000 00010 0020? ????? 000?? 0???? ?????
?2-00 10000 0011? ????? ????? ????? ????? ?1?10
00??? ????0 ????? ?1000 00000 000?0 ????0 ????0?
?1?0? ????1 01?0? 00000 0— -11- 01010 00000
00?00 00020 00000 00020 0-000 11000 000-? 00103
00100 0000? ????0 01010 0???? ????0 00000 00???
?0

Shuvuuia

????? 00101 0001? ?0012 -0001 012- 13-01 10110
01000 10001 0???2 ?3— 1???0 000?? ????1 ?????
00??? ?01- ????0 11000 00000 00010 ????1 ????11
12001 10?14 11110 01100 22000 031- 31000 11000
00001 00000 00010 000?? ????2 20100 000-1 01102
30101 01100 10000 01220 0???? ????? ????0 ????0
??

Sinornis

????? 11100 110?? ?0012 -???1 ????? 1???? ?????
????1 10001 1?1?? ????? ????? ????? ????? ?????
1020- 2000- 21-11 1???? ?01- 0?01? ????1? ????11
13?0? 01?4 12110 12101 20011 13222 41010
22101 01110 00112 00102 ?0120 22212 21000

210-1 01102 -2101 00200 10020 11030 2???? 2????
 2???? 2???? ??

Sinornithoides

????? 00101 00111 ?0002 -101? 2???? ?00?? ?200?
 ?1-00 1000? ?212? 2???? 2???? 2???? 2???? ?21?0
 00001 11110 01110 0000? 01?00 ????0 ?210 ?21?1
 11??? 00?2? ?1110 01000 0— -10- 11000 01000
 00001 0001? 0?102 0?020 ?2112 11000 0030? 11101
 311?0 00100 10000 01121 0???? 2???? 2???? 2???? ??

Sinornithomimus

????? 00001 00011 10010 01001 01000 00000 010?1
 00000 10000 0???? 2???? 01?21 100?? ?2?01 1?1?1
 11— ——— 10000 00000 00010 ?2201 10110 1?10?
 00?23 00101 0?000 0— -11- 11000 01000 00001
 00021 00000 00101 ?2002 11000 100-? 01100 20100
 00100 10000 01220 3???? 2???? 2???? 2???? ??

Sinornithosaurus

????? 00000 01011 10000 11001 01000 11100 10001
 11-00 11111 1?21? 2???? 2???? 0???? 2???? 2????
 00201 (1,2)0001 00001 00000 00100 00100 ?211?
 2???? 11??2 1?222 1?112 0?011 10101 11210 411?1
 11110 00000 00012 ?2101 0???? ?2?11 21001 21301
 11103 011?0 00100 10000 01121 0???? 2???? 2????
 2???? ??

Sinosauropteryx

????? 00000 00011 00000 10001 00000 0?200 01?21
 00000 1000? 0???? 2???? 2???? ?00?? 2???? 2????
 00201 10000 00000 0???? ?201- 0???? ?2?00 ?2100
 01?0? 00?1? ?0100 00000 0— -11- 11000 00000
 00001 00000 ?0011 01000 12012 11000 1010? 01100
 20000 00000 10000 01020 0???? 2???? 2???? 2????
 ??

Sinovenator

????? 00001 01?11 10012 -??21 2???? 0???? ?1???
 2???? 10001 1?22? 2???? 11111 000?1 11?01 21100
 00201 111?0 ?111? 0000? 11??2 2???? ?2?1? ?211?
 01101 00?12 01110 0???? 2???? 2???? 310?1 11010
 00?00 2???? 2???? ?0021 21002 21000 21301 11101
 31100 01000 10000 01021 0???? 2???? 2???? 2????
 ??

Sinraptor

????? 00000 00011 11100 00111 00000 00000 00001
 00000 00000 01100 01110 01101 00001 00?00 ?00-0
 00000 00000 00001 10000 00100 110?0 00111 00100
 02100 02022 0?100 ?0000 21000 01??2 3100? 2????
 2???? 2???? ?2?0? ?1002 10002 11000 10100 01100
 20010 00000 10000 01020 0???? 2???? 2???? 2???? ??

Sphenosuchus

?????1 00000 00010 00001 00001 00000 00000 01112
 02-00 10001 00110 00011 01101 00011 01101 11100
 00100 00000 00000 10000 00000 00000 01010 00100
 00000 0000? 2???? ?0100 0— -01- 10000 02100
 00001 00001 00?2? 2???? 2???? 2???? 2???? 2????
 2???? ?000? 2???? 010?0 0?010 00?2? 2???? 2???? ??

Syntarsus

????? 00100 00011 00000 00001 00000 00000 00000
 00000 00000 0?1?? ?111? 01101 00001 00?00 10100
 00200 20000 00000 00000 00100 00000 00210 01100
 01110 00021 10100 00000 0— -1200 10000 00000
 00001 00000 00011 00000 20-02 11000 000-0 01100
 10000 00200 10010 11020 0???? 2???? 2???? 2???? ??

Terrestrisuchus

????? 2????0 00010 0000? ?0001 00011 00000 01112
 02-00 00000 0?110 0100? 10?1? ?0011 11?21 2????
 00?20 00000 ?200? 00000 00000 00000 0131? ?21?0
 0???? 0????0 00100 01000 00000 001- 10000 01100
 00001 00001 00111 00020 0-012 11000 000-0 00003
 00100 10001 11100 01010 0?000 00111 00000
 01000 00

Troodon

????? ?21?? 0?211 ?0012 -1001 01000 2???? ?11??
 ?0000 00001 0?2?0 2???? 11101 10011 11111 1011?
 00001 11111 01000 0010? 01?2? 2???? 2???? ?2111
 11101 00113 0?1?0 010?? 2???? 2???? 2???? 2????
 2???? 0000? ?2111 00?2? 2???? 01?00 102?1 11101
 3110? ?0200 10000 01121 0???? 2???? 2???? 2???? ??

Tyrannosaurus

????? 00000 00011 10102 -0111 00000 00000 01001
 00100 01101 01120 00111 01111 000?1 00?01 10000
 00010 00000 00000 00000 00100 11000 01301 00100
 01100 02022 01100 00000 — -1200 21000 00000
 00001 00000 00010 01002 10002 11000 10101 01100
 30000 00000 10000 01120 0???? 2???? 2???? 2???? ??

Unenlagia

????? 2???? 2???? 2???? 2???? 2???? 2???? 2????
 2???? 2???? 2???? 2???? 2???? 2???? 2???? 2????
 2???? 2???? 2???? 2???? 2???? ?21?? ?11?1 121?3
 2???? 2???? 2???? 2???? 3101? 2???? ?2?00 00001
 00?2? ?0121 21001 01000 21301 11101 301?? 2????
 2???? 2???? 2???? 2???? 2???? 2???? ??

Velociraptor

????? 00000 00011 10002 -1001 01000 01000 10001
 00000 11110 01120 01111 11101 001?1 00?01 11100

00000 00000 00000 10000 00100 10100 00311 10110
11101 1?123 11112 01011 10101 11200 31001 11010
00000 00001 00101 00011 21102 21000 20301 11101
31100 00000 10000 01021 0???? ???? ???? ???? ??

Yanornis

???? 11100 11010 00012 -1001 1— 1???2 ????1
?2-00 10000 1???? ???? ???? ???? ???? ????0
00202 200?- 21111 1?000 0001- 0???? ???? ??1??
???? ?1??4 1???? 2???? 22011 12211 41011 ?2101
10?10 01112 ????1 ??1?? ????1? 21000 00??? 0????
????1 00200 10020 21030 2???? ???? ???? ???? ??

APPENDIX 5: NOTES ACCOMPANYING MATRIX ON SCORING DECISIONS FOR CERTAIN TAXA

Alligator

Character 125: Contrast figure 3 of Mook (1921) with plate 18 of Madsen (1993).

Character 197: The condition in *Alligator* is similar to that in *Marasuchus* (see fig. 9A of Sereno and Arcucci 1994).

Alxasaurus

Character 129: Russell and Dong (1993b) present no evidence to show that all the presacral vertebrae were pneumatized.

Archaeopteryx

Character 96: See Martin and Stewart (1999), whose account we confirmed by personal observation of casts at UKMNH, contrary to the description of Elzanowski and Wellnhofer (1996).

Character 221: Following Mayr et al. (2005, 2007).

Avimimus

Character 40: See figure 1a of Kurzanov (1985).

Character 80: Kurzanov (1985) described teeth in the type specimen, but these are really denticles formed by the crenulate margin of the premaxillae (Vickers-Rich et al. 2002).

Citipati

Character 103: See Elzanowski (1999).

Compsognathus

Character 20: Although it is not preserved as a separate element, a sutural facet on the anteroventral edge of the left frontal probably indicates that the prefrontal was present in life (Ostrom 1978:83).

Conchoraptor

Character 103: See Elzanowski (1999).

Character 151: Clark et al. (2002) did not code the acromion as laterally everted, whereas Maryńska et al. (2002) did. Osmólska et al. (2004) stated that the acromion of oviraptorosaurs is distinctly laterally everted in contrast to that of most theropods. This state is clearly illustrated by the scapulocoracoid of *Ingenia* (fig. 8.2G, H of Osmólska et al. 2004).

Deinonychus

Character 20: Currie (1995:580) provides the justification for this coding.

Dibrothosuchus

Character 163: See fig. 10C of Wu and Chatterjee (1993).

Erlikosaurus

Character 103: See Elzanowski (1999).

Erpetosuchus

Character 148: Although the clavicles are not preserved with the skeleton, an attachment for them is present on the scapula according to Benton and Walker (2002:33).

Erythrosuchus

Character 129: Gower (2001) detailed the presence of pneumatic dorsals in *Erythrosuchus* but demurred in his 2003 monograph on this taxon. Nonetheless, his earlier arguments were compelling and are followed here.

Euparkeria

Character 127: Ewer (1965:429) discusses "central excavations" in the vertebral column, which she suggests are related to the pneumatic excavations of the vertebrae in birds and some other archosaurs. Because these are not clearly illustrated and their nature remains uncertain (see also Gower 2001), we have coded this character and character 129 as unknown.

Gallimimus

Character 103: See Elzanowski (1999) and Hurum (2001).

Gansus

Character 140: Costal facets do not appear to occur on the sternum (see fig. S4 of You et al. 2006, supplementary material).

Harpymimus

Character 103: See Elzanowski (1999).

Herrerasaurus

Character 186: Contrary to Paul (2002), the pubis, despite being somewhat posteriorly reflected, is not actually retroverted as it is in maniraptorans and birds.

Heyuannia

Character 103: See Elzanowski (1999).

Hongshanornis

Character 140: Costal facets do not appear to occur on the sternum (see fig. 4 of Zhou and Zhang 2005).

Longisquama

Character 14: Our examination of high-quality stereo photographs and casts of the *Longisquama* material available at UKMNH confirmed the presence of the antorbital fenestra (see Fig. 15).

Character 15: Martin (2004, fig. 4D) restored the skull of *Longisquama* with two accessory antorbital fenestrae, of which we could confirm the presence of one (see Fig. 15).

Ornithosuchus

Character 103: See Walker (1964:76, 115); see also Walker (1961) and Romer (1956).

Patagopteryx

Character 141: The sternum is not completely known, but no evidence indicates a suture or that the sternal plates were unfused.

Postosuchus

Character 15: See figure 3b of Chatterjee (1985).

Character 129: See Gower (2001) and Chatterjee (1985:417–418, fig. 12).

Protopteryx

Character 208: Although the tibia is referred to as a tibiotarsus by Zhang and Zhou (2000), the proximal tarsals are not fused to the tibia, as is apparent from the description of the tarsus (Zhang and Zhou 2000:1956–1957), and the term “tibiotarsus” is therefore inappropriate.

Sapeornis

Character 160: Zhou and Zhang (2003a:736) regard the “biceps tubercle” of the coracoid in *Sapeornis*

as homologous with the acrocoracoid process, but the structure is not appreciably different from that found in some theropods and in *Archaeopteryx*, in which taxa an acrocoracoid is absent.

Scleromochlus

Character 154: See figure 2a of Benton (1999), which shows a cast of the dorsal slab of BMNH R3146, clearly indicating that the scapula is positioned parallel to the vertebral column, as also reported by Martin (1983, 2004). Benton’s figure 14, however, shows *Scleromochlus* restored with the scapula far down the ribcage and not parallel to the vertebrae.

Character 165: The orientation of the scapula necessitates a lateral orientation for the glenoid fossa.

Shuvuuia

Character 20: We concur with Chiappe et al. (2002), rather than with Sereno (2001), on the interpretation of the preorbital region of *Shuvuuia*.

Sinornis

Character 14: Martin and Zhou (1997) provided a reconstruction of the antorbital cavity for the referred specimen (IVPP V 9769) that we could not confirm from observation of the casts available to us. A clear antorbital cavity cannot be distinguished. Sereno et al. (2002:189) also note difficulties in deciphering the structure of the antorbital cavity.

Character 15: Martin and Zhou (1997) restored the antorbital fossa as being pierced by an accessory maxillary fenestra, but we could not confirm this character from personal observation of the specimen or from other descriptive accounts in the literature. Sereno et al. (2002:189) suggested the possible presence of this accessory fenestra, but the antorbital region is too poorly preserved for certainty. Sanz et al. (1997) noted the absence of such a fenestra in the skull of a hatchling enantiornithine from Spain.

Character 22: Martin and Zhou (1997) asserted that a “T-shaped” lacrimal is present in the referred specimen. We could not confirm this character upon inspection of the casts available to us, and Sereno et al. (2002) made no mention of a lacrimal in their description of the cranial anatomy of *Sinornis*.

Character 34: Martin and Zhou (1997) stated that “there is a well preserved quadrate . . . lying

disarticulated and behind one skull. . . ,” but inspection of the skull of the referred specimen fails to corroborate this assertion, a conclusion also reached by Sereno et al. (2002).

Character 127: Although the pleurocoels are poorly preserved in the holotypic specimen, an isolated dorsal with a distinct pleurocoel is present in the specimen examined.

Sinornithoides

Character 20: See Currie and Dong (2001:1755).

Character 208: Although *Sinornithoides* is often described as possessing a fully avian tibiotarsus, only the proximal tarsals are in fact fused.

Sinornithosaurus

Character 33: The quadratojugal has drifted away from the quadrate in the skull of IVPP V 12811 (fig. 2 of Xu and Wu 2001), which suggests that it was only ligamentously attached.

Character 42: See Xu and Wu (2001:1750) for the coding of this character.

Character 185: Some medial closure of the acetabulum was noted by Xu et al. (1999b) and is apparent in their fig. 4e.

Sphenosuchus

Character 112: See Walker (1990:53 and fig. 34g).

Character 129: No pneumatic features occur in any of the vertebrae figured by Walker (1990).

Character 166: See Sereno (1991:27).

Terrestrisuchus

Character 37: Crush (1984) figured what clearly appears to be a pneumatic foramen perforating the quadrate, though no clear reference appears in the text to the presence or absence of this character. A similar foramen is found in *Dibrothosuchus*

and *Sphenosuchus*. In the former, we consider it a foramen transmitting the “temporo-orbital” (= stapedia) artery, but in *Sphenosuchus* it is probably a pneumatic feature.

Character 71: In contrast to the condition in *Sphenosuchus*, clear evidence shows that the metotic fissure had been subdivided by a prevagal commissure.

Character 141: Walker (1990:64, and unpublished correspondence dated 29 October 1995) disputed the identification of the ossified median element identified by Crush (1984, fig. 7B) as a sternum. He argued that it was in fact an interclavicle. His reasoning, though perhaps applicable to a similar element in *Sphenosuchus*, certainly does not hold in the case of *Terrestrisuchus*, in which Crush (1984) clearly identified another element as the interclavicle and a second median element in the pectoral girdle as the sternum. Given that the coracoids articulate directly with this second median element, we conclude that Crush (1984) was correct and that this element is a sternum.

Character 143: Unpublished correspondence from A. D. Walker dated 29 October 1995 notes that examination of the element Crush (1984) identified as a sternum failed to reveal any trace of rib facets.

Troodon

Character 20: See Gauthier (1986) for commentary on the structures Currie (1985) identified as prefrontals.

Yanornis

Character 149: Zhou and Zhang (2001) describe the furcula as “U-shaped,” but their figure 2 (p. 1259) clearly illustrates a furcula that does not appreciably differ from that of *Archaeopteryx* or *Confuciusornis*, except for the presence of a small hypocleidium.